

KONFORT TOUCH



Rev.

TEXA

ENGLISH (US).....5

SUMMARY (US)

1	REVISION OF THE MANUAL	5
2	INTRODUCTION	6
3	LEGEND OF THE SYMBOLS USED	7
4	SAFETY RULES	8
4.1	Glossary	8
4.2	General Rules	9
4.3	Operator Safety	9
4.4	Device Safety	11
4.5	Safety Devices	12
4.6	Safety Precautions to follow when using the Refrigerants	13
4.7	Workplace Safety	13
4.8	Guidelines for Handling the Refrigerants Used	13
4.8.1	Refrigerant Storing Precautions	13
4.8.2	Refrigerant and System Conditions	14
4.8.3	Recycling Capacity	14
4.8.4	In General	14
5	NORMATIVE INFORMATION	15
6	OPERATION OF THE RADIO DEVICES	16
7	KONFORT TOUCH CHARGING STATIONS	17
7.1	KONFORT 720 TOUCH	18
7.2	KONFORT 760 TOUCH	19
7.3	KONFORT 760 BUS TOUCH	20
7.4	KONFORT 780 TOUCH	21
8	DESCRIPTION	22
8.1	Containers	26
9	INSTALLATION	27
9.1	Unpacking the Device	28
9.2	GAS KIT installation	28
10	HANDLING	30
10.1	Scale Lock / Unlock	30
10.2	Moving the Device	31
10.3	Positioning	32

11	POWER SUPPLY	33
12	POWER ON/OFF	34
12.1	Stopping the Equipment for Long Periods.....	34
13	SETTING UP BEFORE USING	35
13.1	How to Fill the Bottles.....	35
13.2	How to Fill the Internal Tank.....	36
13.3	How to Load the Paper into the Printer.....	36
13.4	Initial Configuration.....	37
13.4.1	Demo Mode.....	37
14	COMMUNICATION	39
14.1	Wi-Fi.....	39
14.2	Bluetooth.....	40
14.3	USB.....	40
15	User Instructions	41
16	UPDATING	42
17	MAINTENANCE	43
17.1	Ordinary Maintenance.....	43
17.1.1	Dehydrator Filter Replacement.....	44
17.1.2	Mechanical Filter Replacement.....	46
17.1.3	How to Replace the Vacuum Pump Oil.....	47
17.1.4	Replacing the Paper in the Printer.....	47
17.2	Periodical Checks.....	48
17.3	Periodical Safety Checks.....	48
18	TECHNICAL FEATURES	49
19	DATA PLATE	52
20	HYDRAULIC DIAGRAMS	53
21	DISPOSAL	57
21.1	How to Dispose of the Device.....	57
21.2	How to Dispose of the Recycled Materials.....	57
22	LEGAL NOTICES	58

1 REVISION OF THE MANUAL

This document is the technical manual for the product: KONFORT TOUCH charging stations

Document Revision Number: 04

Date of Issue: 19/09/2023

INFORMATION	<i>Read this manual before using the product. Read the documents carefully whenever the General Risk symbol appears.</i>
	

2 INTRODUCTION

Dear Customer,

We would like to thank you for choosing a TEXA product for your workshop.

We are certain that you will get the greatest satisfaction from it and receive a great deal of help in your work.

Please read through the instructions in this manual carefully and keep it for future reference.

Reading and understanding the following manual will help you avoid damage or personal injury caused by improper use of the product to which it refers.

TEXA S.p.A reserves the right to make any changes deemed necessary to improve the manual for any technical or marketing requirement; the company may do so at any time without prior notice.

This product is intended for use by technicians specialized in the automotive field only. Reading and understanding the information in this manual cannot replace adequate specialized training in this field.

The sole purpose of the manual is to illustrate the operation of the product sold. It is not intended to offer technical training of any kind and technicians will therefore carry out any intervention under their own responsibility and will be accountable for any damage or personal injury caused by negligence, carelessness, or inexperience, regardless of the fact that a TEXA S.p.A. tool has been used based on the information in this manual.

Any additions to this manual, useful in describing the new versions of the program and new functions associated to it, may be sent to you through our TEXA technical bulletin service.



















This manual should be considered an integral part of the product to which it refers. If it is resold the original buyer is therefore required to forward the manual to the new owner.





Reproduction, whole or in part, of this manual in any form whatsoever without written authorization from the manufacturer is strictly forbidden.

The original manual was written in Italian, every other language is a translation of the original manual.

© **copyright and database rights 2022.** The material contained in this publication is protected by copyright and database rights. All rights are reserved by law and under international conventions.

3 LEGEND OF THE SYMBOLS USED

	Toxic material hazard		Risk of crushing hands
	Explosive material hazard		Floor level obstacle warning
	Electric shock hazard		Laser beam hazard
	Electromagnetic field hazard		Low temperature danger - freezing
	Flammable material hazard		General Risk
	Hot surface hazard		Read instructions
	Corrosive substance hazard		Safety glasses required
	Risk of noise level above 80 dB(A)		Protective gloves required
	Moving Parts Risk		Disconnect mains plug from electrical outlet

	This is not a safety symbol. It indicates a hazardous situation that, if not avoided, will result in serious permanent injury or death.
	This is not a safety symbol. It indicates a hazardous situation that, if not avoided, may result in serious permanent injury or death.
	This is not a safety symbol. It indicates a hazardous situation that, if not avoided, may result in minor injury.
	This is not a safety symbol. It indicates a hazardous situation that, if not avoided, may result in material damage.
	This is not a safety symbol. It indicates important information.

4 SAFETY RULES

The technology used for the design and manufacturing control of the **KONFORT TOUCH** charging stations make them simple, reliable and safe to use.

The personnel in charge of using the charging stations is required to follow the general safety rules, use the charging stations for their intended use only and keep them properly, as described in this manual.

All the requirements based on the following must be assessed and applied:

- *Labor inspectorate.*
- *Trade associations.*
- *Vehicle manufacturers.*
- *Anti-pollution regulations.*

4.1 Glossary

- **Equipment:** *any KONFORT TOUCH charging station.*
- **Operator:** *qualified individual in charge of using the equipment.*
- **External cylinder:** *new cylinder for R134a or R1234yf refrigerant used to fill the internal tank.*
- **Cycle:** *the carrying out of single phases.*
- **Operating phase:** *the carrying out of a single operation by the equipment (i.e. recycling).*
- **Non-condensable gas:** *air accumulated during the vapor phase in the refrigerant, extracted from the A/C system or from the tanks.*
- **UV tracer injection:** *introduction of UV tracer into the A/C system in order to check for leaks.*
- **Oil injection:** *introduction of oil into the A/C system in order to restore the correct quantity recommended by the manufacturer.*
- **Operator:** *qualified individual in charge of servicing air conditioning systems using a charging station.*
- **Recovery:** *removal of the refrigerant from the A/C system and the subsequent storage in the internal tank, without the need for analysis or treatment.*
- **Refrigerant:** *coolant (R134a or R1234yf).*
- **Recycling:** *reduction of the contaminants in the refrigerants used by separating the oil, removing the non-condensable gases and passing the refrigerant once (or multiple times) through elements that reduce the humidity, acidity, etc.*
- **Refilling:** *refrigerant charging phase; it charges the A/C system with the amount of refrigerant recommended by the manufacturer.*
- **Internal tank:** *tank for storing the refrigerant.*
- **A/C system:** *air conditioning or climate control system.*
- **Disposal of the equipment:** *removal of the refrigerant destined to be stored in order to be disposed of later (destroyed or transferred to waste disposal plants).*
- **Vacuum:** *the evacuation of non-condensable gases and humidity from the A/C system exclusively through a vacuum pump.*

INFORMATION

The definition of "operator" cannot be applied to minors or to people with reduced physical, sensory or mental capabilities or without any experience or knowledge required.

4.2 General Rules



The operator must carefully read and understand all the information and instructions in the technical documents provided with the equipment. If the operator is not able to read this manual, the operating instructions and safety indications must be read and discussed in the operator's native language.

- *The operator must have basic knowledge of refrigeration, the refrigeration system, refrigerants and the potential hazards that equipment under extreme pressure can cause.*
- *The operator who works on vehicles must have basic qualifications and knowledge of mechanics, automotive engineering, vehicle repairing and of the potential dangers that may arise during self-diagnosis operations.*
- *The operator must be completely clear-headed and sober and not take drugs nor drink alcohol before or when using the equipment.*
- *The operator must follow all the instructions provided in the technical documents.*
- *The operator is required to wear appropriate Personal Protective Equipment (PPE) at all times when using the equipment.*
- *The operator must monitor the equipment during the operating phases wherever this is possible in compliance with the safety measures indicated below.*
- *The operator must periodically check the electrical connections of the equipment, making sure they are in good condition and immediately replacing any damaged cables.*
- *The operator must periodically check the parts that are subject to wear and replace them if needed, using only original spare parts or spare parts approved by the manufacturer.*
- *The operator must stop using the equipment immediately should any failure occur, and promptly contact the technical assistance.*
- *Contact your retailer for extraordinary maintenance operations.*
- *Do not remove or damage the labels/tags and the warnings on the equipment; do not in any case make them illegible.*
- *Do not remove or tamper with any safety devices the equipment is provided with.*

4.3 Operator Safety

WARNING

Refrigerant fluids can cause blindness and other physical injuries.



Due to their low boiling temperature (approximately - 30 °C), refrigerants can cause cold burns when they come into contact with the skin.

Safety Measures:

- *The operator must avoid inhaling the vapors of the refrigerant liquids; use appropriate protection when required.*
- *The operator is required to wear appropriate safety glasses and gloves that prevent direct contact with the refrigerants.*

- *Do not use the equipment near open flames, sparks, hot surfaces: the refrigerant decomposes at high temperatures, letting off toxic chemical substances that are harmful to people and the environment.*

CAUTION

The equipment has been designed to be steady both when being moved and once it is positioned.

However, you must pay attention while moving it.



Safety Measures:

- *Do not tilt the equipment in any way.*
- *Do not step on the equipment.*
- *Do not hang loads that may compromise the stability of the equipment, causing it to tip over.*
- *To move the equipment, use the specific handle only and balance the station on its wheels.*
- *Avoid moving it on uneven surfaces.*

CAUTION

The equipment was designed to be electrically safe and to work with specific supply voltage levels.

Improper use may expose the operator to the risk of electric shock, even though of low intensity.



Safety Measures:

- *Wear appropriate personal protective equipment during all the operating phases.*
- *Do not handle or touch the equipment or any accessories (e.g. cables) with wet hands.*
- *Do not use extension cords to power the equipment.*

WARNING

The current used during the operating phases may generate Electromagnetic Fields (EMF) near the equipment.

Even though of low intensity, these fields may interfere with medical prostheses, such as pacemakers.



Safety Measures:

- *Keep away from the equipment after launching the operating phases.*
- *If you have a medical prosthesis (e.g.: pacemaker), check with your doctor as to the appropriateness of using the equipment or being near it.*

4.4 Device Safety

NOTICE



The equipment was designed in compliance with the regulations on pressure equipment and assemblies, evaluating and reducing the risk where present and making appropriate considerations.

However, vibrations, pressure variations or excessive temperatures, especially if cyclic, should be avoided.

Safety Measures:

- *During use, do not move out of the TS operating temperature range and do not exceed the PS maximum operating pressure (see plate on the equipment).*
- *Only use refrigerants R134a or R1234yf.*
- *Make sure you use the correct refrigerant for the model of the device you are using.*
- *Make sure you use the correct refrigerant for the vehicle you are working on.*
- *Connect the hoses correctly by following the colors indicated: Blue hose - LP coupler, Red hose - HP coupler.*
- *Connect both hoses to the corresponding connections of the same group (both hoses connected to GAS1 group or both hoses to the GAS2 group).*
- *Make sure all the valves are closed before connecting the device to the A/C system or to an external cylinder.*
- *Make sure the operating phase has ended and that the valves are closed before disconnecting the device; this should be done to avoid the refrigerant from spreading into the atmosphere.*
- *It is absolutely forbidden to modify the calibration of the safety valves and the control systems.*
- *Do not smoke near the device or during the operating phases.*
- *Do not expose the device to direct sunlight, rain and bad weather conditions.*
- *Disconnect the hoses with extreme caution; they may contain refrigerant under high pressure.*
- *Make sure the couplers are not open when the hoses are placed back around the service hose holder.*
- *Do not leave the device connected to the power supply if you do not intend to use it immediately.*

NOTICE



The equipment was designed to be used in specific environmental conditions.

Using the equipment in environments with temperatures and humidity that differ from those specified may impair its efficiency.

Safety measures:

- *Place the equipment in a dry area.*
- *Do not expose or use the equipment near heat sources.*
- *Place the equipment where it can be properly ventilated.*
- *Do not use corrosive chemicals, solvents or harsh detergents to clean the equipment.*

- *If storing the device for a long period of time, disconnect it from the power mains and put it in a safe place, where it is not exposed to outside weather conditions.*

NOTICE



The equipment was designed to be mechanically sturdy and suitable for use in a workshop.

Careless use and excessive mechanical strain may impair its efficiency.

Safety measures:

- *Do not drop, shake or bump the equipment.*
- *Do not place the equipment where it could fall into water. Avoid any contact with water.*
- *Do not place any objects on the cables or service hoses.*
- *Do not perform any kind of intervention that may damage the equipment.*
- *Do not use the touchscreen with sharp objects or any other kind of object that may damage it.*
- *Do not access the components inside the equipment unless explicitly requested by specific maintenance operations indicated in this manual.*

NOTICE



The equipment was designed to be electrically safe and to work with specific supply voltage levels.

Failure to comply with the specifications related to the power supply may impair its efficiency.

Safety measures:

- *Do not expose the equipment to water or other liquids.*
- *Do not use external batteries to power the equipment.*
- *Do not use extension cords to power the equipment.*

! WARNING



The electromagnetic compatibility tests carried out on the tool guarantee that it can be adapted to the technologies normally used on vehicles (e.g.: engine check, ABS, airbag, etc.). Nevertheless, if malfunctions occur you should contact the vehicle's dealer.

4.5 Safety Devices

This equipment is provided with the following safety devices:

- **Safety pressure switch:** *it stops the compressor when the pressure reaches a cut-off level.*
- **Safety valve:** *it opens completely if the PS value is reached.*
- **Main switch:** *it allows cutting off the power from the mains in case of an emergency or to carry out maintenance.*

Tampering with the above mentioned safety devices of any kind is strictly forbidden.

4.6 Safety Precautions to follow when using the Refrigerants

WARNING



Some mixtures of air and refrigerant have proved to be combustibile at high pressures.

These mixtures are potentially hazardous and can cause fires and explosions, causing personal injuries and damage to objects.

Further safety and medical information can be obtained from the lubricant and refrigerant manufacturers.

Safety Measures:

- Do not use external tanks or other storage systems that have not been approved and/ or that are not equipped with safety valves.
- Do not test the equipment or the vehicle A/C system containing R134a with compressed air.

WARNING



The refrigerant R1234yf has been classified as flammable.

Safety Measures:

- See the safety sheet of this refrigerant to store it correctly.

4.7 Workplace Safety

NOTICE



The device is designed to work at a maximum altitude of 1000 m above sea level, with an operating temperature between 5 °C and 40 °C and a maximum humidity of 50% at 50 °C.

Safety Measures:

- This equipment should be used in locations with mechanical ventilation that provides at least four air changes per hour or the equipment should be used at least 0,5 m above the floor/ground.
- Keep the device in environments with temperatures that do not exceed 50 °C.
- Only use the device in open or well-ventilated environments (at least 4 air changes per hour).
- Make sure the workplace is well-lit (average operating illuminance, for mechanic workshops and assembly on work benches for precision work, is 500-750-1000 lux).

4.8 Guidelines for Handling the Refrigerants Used

4.8.1 Refrigerant Storing Precautions

The equipment has been designed and built to operate with R134a or R1234yf refrigerants only.

- *The refrigerant removed from the A/C system must be handled with care to prevent the refrigerants from mixing or in any case reduce the risk of this happening.*
- *The cylinders used for refrigerant storing must be specific for each refrigerant to avoid mixing the refrigerants.*
- *The cylinders must be perfectly clean and clearly labelled in order to identify the refrigerant they contain.*

4.8.2 Refrigerant and System Conditions

The installation procedures and the maintenance carried out during the operating life of the A/C system substantially affect the quality of the refrigerant.

Understanding these factors is essential in order to decide whether or not the refrigerant from a system should be recycled.

The systems that have not been properly maintained (not cleaned, not emptied correctly, etc.) can have high contamination levels, both in the refrigerant and in the oil.

If the history of the system is not known, the refrigerant recovered must at least be recycled before it is reused.

When the contamination level is not known, you may carry out some preliminary checks with the kit specifically for acidity and humidity measurements.

4.8.3 Recycling Capacity

The filtering systems of the device must be replaced regularly in order to guarantee device efficiency.

The recycling must always be carried out, even when tests do not show that they are required.

4.8.4 In General

Before carrying out the refrigerant refilling phase, the A/C system must be emptied and cleaned (a vacuum operation must be carried out).

Carry out all the procedures as described in this manual in order to guarantee that the A/C system is not contaminated.

Carry out the scheduled/regular maintenance on the device as required, especially after it has been used with a highly contaminated refrigerant: it is essential that the contamination from one operation is not passed on to the following one.

5 NORMATIVE INFORMATION

Declaration of Conformity

	<p>Texa S.p.A. hereby declares that this KONFORT TOUCH charging station:</p> <ul style="list-style-type: none">• 720• 760• 760 BUS• 780 <p>complies with the essential requirements and with all further provisions defined by the following directives:</p> <ul style="list-style-type: none">• <i>2014/18/EU PED</i>• <i>2014/30/EU EMC</i>• <i>2014/35/EU LVD</i>• <i>2006/42/EC MD</i>• <i>2014/53/UE RED</i>• <i>2011/65/EU RoHS</i>• <i>Delegated Directive 2015/863</i>
---	--

The Declaration of Conformity is available in paper format along with the other documents provided with the equipment.

A copy of the Declaration of Conformity is available by contacting Texa S.p.A., Via 1 Maggio 9, 31050 Monastier di Treviso (TV), Italy

6 OPERATION OF THE RADIO DEVICES

Wireless connection with Bluetooth and Wi-Fi technology

The wireless connectivity with Bluetooth and Wi-Fi technology supplies a standard and reliable way to exchange information between different devices, using radio waves. Other than TEXA products, even products such as cellular phones, portable devices, computers, printers, cameras, Pocket PCs, etc. use this type of technology.

The Bluetooth and Wi-Fi interfaces look for compatible electronic devices according to the radio signal they emit and establish a connection between them. TEXA tools select and only prompt you with compatible TEXA devices. This does not exclude the presence of other sources of communication or disturbance.

THE EFFICIENCY AND THE QUALITY OF THE BLUETOOTH AND Wi-Fi COMMUNICATIONS MAY BE INFLUENCED BY THE PRESENCE OF RADIO DISTURBANCE SOURCES. THE COMMUNICATION PROTOCOL HAS BEEN DEVELOPED TO MANAGE THESE TYPES OF ERRORS; HOWEVER, IN THESE CASES COMMUNICATION MAY BECOME DIFFICULT AND CONNECTION MAY REQUIRE SEVERAL ATTEMPTS.

SHOULD THE WIRELESS CONNECTION BE CRITICAL AND COMPROMISE A REGULAR COMMUNICATION, THE SOURCE OF THE ENVIRONMENTAL ELECTROMAGNETIC DISTURBANCE MUST BE IDENTIFIED AND ITS INTENSITY MUST BE REDUCED.

Position the tool so that the radio devices it is equipped with can work properly. In particular, do not cover it with any shielding materials or with any metallic materials in general.

7 KONFORT TOUCH CHARGING STATIONS

The **KONFORT TOUCH** charging stations are designed for servicing A/C and climate control systems on cars, trucks, buses and tractors.

The **KONFORT TOUCH** stations are high-performance and capable of carrying out the following operations in complete safety: recovery, recycling, vacuum, oil injection, UV tracer injection, system refilling and A/C system performance check.

The **TOUCH** series includes the following models:

- **720**
- **760**
- **760 BUS**
- **780**

The charging stations that can be purchased in the version that works with the **R134a** gas or with the **R1234yf** gas are:

- **720**
- **760**
- **760 BUS**

A kit containing specific fittings for the version purchased (**GAS KIT**) is provided along with these models.

The **GAS KIT** must be installed following the instructions described in the chapter **Installation**.

The stations purchased in the version that operates with the **R134a** refrigerant can be retrofitted at any time, so that it can operate with the new **R1234yf** refrigerant.

The modification requires the installation of a specific **RETROFIT KIT** (optional).

The **780** charging stations are designed, and already set up, to operate with both refrigerants.

These charging stations are not equipped with a **GAS KIT** as they are supplied already ready for use.

7.1 KONFORT 720 TOUCH

KONFORT 720 TOUCH can operate on cars, trucks and tractors.

MAIN FEATURES



- *R134a or R1234yf compatible*
- *10" TFT touchscreen display*
- *Advanced graphic interface*
- *DATABASE and performed services management*
- *12 kg tank*
- *Double stage vacuum pump*
- *High efficiency refrigerant recovery (over 95%)*
- *Automatic oil injection (timed operation)*
- *2 manual (turn wheel) valves for AC service hoses*
- *Band heater*
- *Operating modes:*
 - *DATABASE*
 - *CUSTOMIZED SERVICE*
 - *MY DATABASE*
- *Multilingual software coverage*
- *Service hoses automatic length offset*
- *Automatic maintenance warning*
- *Simplified maintenance*
- *Incondensable gases automatic drain management*

7.2 KONFORT 760 TOUCH

The **KONFORT 760 TOUCH** charging station is dedicated to the most demanding operators. **KONFORT 760 TOUCH** can operate on cars, trucks and tractors.

MAIN FEATURES



- *R134a or R1234yf compatible*
- *10" TFT touchscreen display*
- *Advanced graphic interface*
- *DATABASE and performed services management*
- *20 kg tank*
- *Double stage vacuum pump*
- *High efficiency refrigerant recovery (over 95%)*
- *Anti-contamination airtight oil bottles (patent pending)*
- *High precision automatic oil injection*
- *Automatic oil bottle recognition (patent pending)*
- *Automatic refrigerant accurate quantity control (patent pending)*
- *Scale locking system*
- *Automatic maintenance service management*
- *Band heater*
- *Operating mode:*
 - *DATABASE*
 - *CUSTOMIZED SERVICE*
 - *MY DATABASE*
- *Multilingual coverage of the software*
- *Service hoses automatic length offset*
- *Automatic maintenance warning*
- *Simplified maintenance*
- *Automatic management of non-condensable gases*

7.3 KONFORT 760 BUS TOUCH

The **KONFORT 760 BUS TOUCH** charging station has been specifically developed to operate within the "large climate control systems" sector.

KONFORT 760 BUS TOUCH can operate on cars, trucks, tractors, buses, coaches and similar vehicles.



MAIN FEATURES

- *R134a or R1234yf compatible*
- *10" TFT touchscreen display*
- *Advanced graphic interface*
- *DATABASE and performed services management*
- *30 kg tank*
- *Two-stage vacuum pump*
- *High efficiency refrigerant recovery (over 95%)*
- *Anti-contamination airtight oil bottles (patent pending)*
- *High precision automatic oil injection*
- *Automatic oil bottle recognition (patent pending)*
- *Automatic refrigerant accurate quantity control (patent pending)*
- *Scale locking system*
- *Automatic maintenance service management*
- *Band heater*
- *Operating mode:*
 - *DATABASE*
 - *CUSTOMIZED SERVICE*
 - *MY DATABASE*
- *Multilingual coverage of the software*
- *Service hoses automatic length offset*
- *Automatic maintenance warning*
- *Simplified maintenance*
- *Incondensable gases automatic drain management*

7.4 KONFORT 780 TOUCH

The **KONFORT 780 TOUCH** charging station is the top of line within the **TOUCH** series. **KONFORT 780 TOUCH** can operate on cars, trucks and tractors.

MAIN FEATURES



- *R134a and R1234yf refrigerant dual line management*
- *10" TFT touchscreen display*
- *Advanced graphic interface*
- *DATABASE and performed services management*
- *2 12-kg tanks*
- *Two-stage vacuum pump*
- *High efficiency refrigerant recovery (over 95%)*
- *Anti-contamination airtight oil containers (patent pending)*
- *High precision automatic oil injection*
- *Automatic oil bottle recognition (patent pending)*
- *Automatic refrigerant measurement accuracy check (patent pending)*
- *Scale locking system*
- *Automatic maintenance service management*
- *2 band heaters*
- *Operating modes:*
 - *DATABASE*
 - *CUSTOMIZED SERVICE*
 - *MY DATABASE*
- *Multilingual software coverage*
- *Automatic service hose length compensation*
- *Automatic maintenance alarm*
- *Simplified maintenance*
- *Automatic management of non-condensable gases*
- *Thermal printer*

8 DESCRIPTION

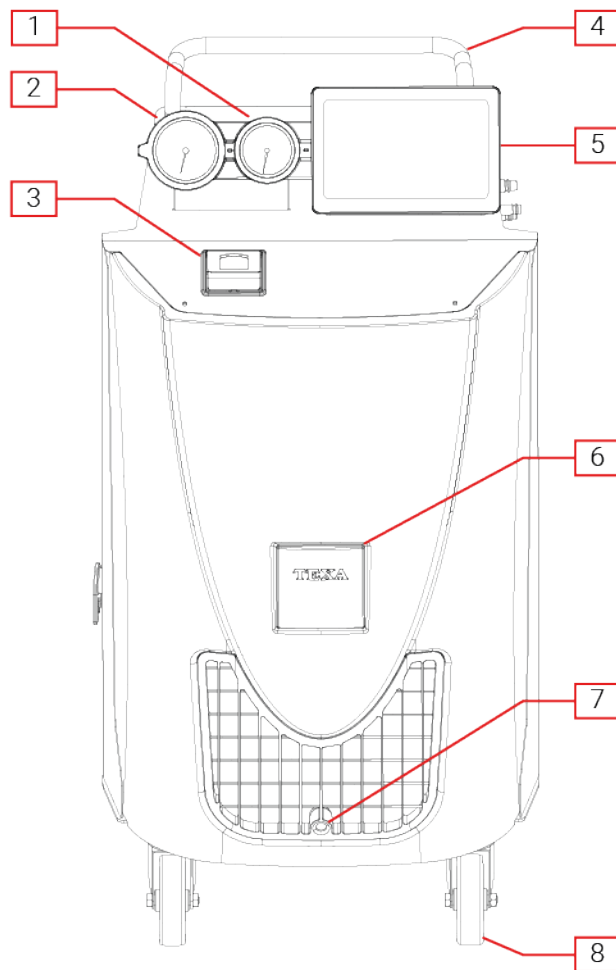

1. Low Pressure gauge (**LP**)
2. High Pressure gauge (**HP**)
3. Printer ¹
4. Handle
5. Controller
Touchscreen
Bluetooth and Wi-Fi communication modules
6. Cylinder compartment door
7. Scale locking / unlocking control ²
8. Castors

*(¹) Supplied only with the charging station model **780**.*

*(²) Not available on the charging station model **720**.*

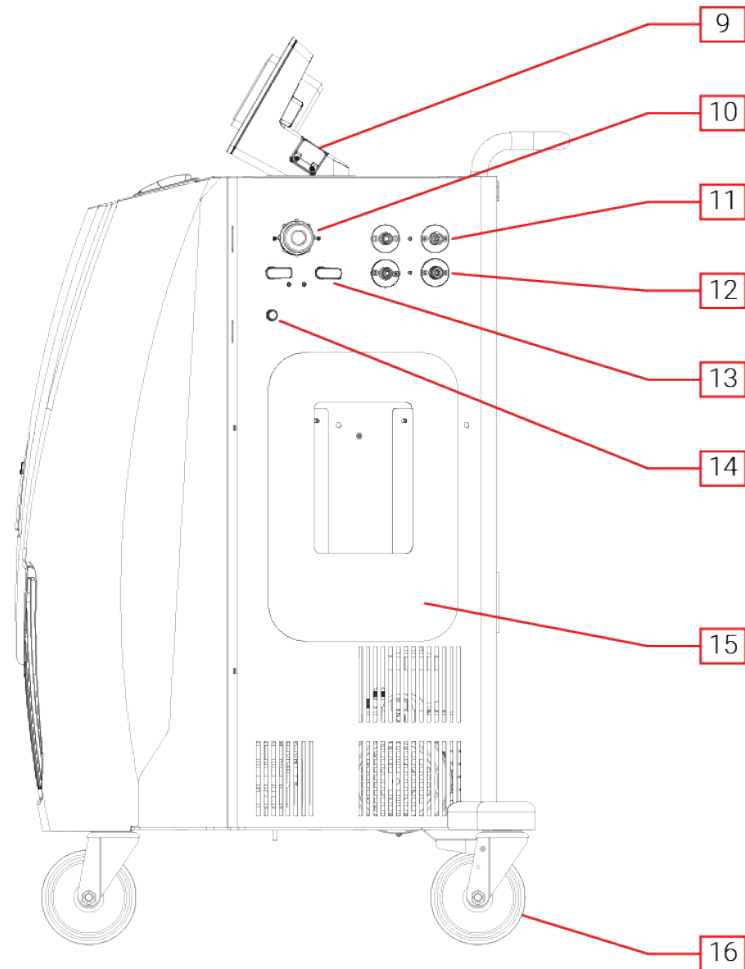

- 9. USB connector compartment
- 10. Setup for the **Refrigerant Identifier**³
- 11. **GAS 2**:HP/LP couplers for gas R1234yf⁴
- 12. **GAS 1**:HP/LP couplers for gas R134a⁵
- 13. HP/LP taps⁶
- 14. Evacuation nozzle⁷
- 15. Service hose holder
- 16. Castors with brakes

^(3,7)Not available on the charging station model **720**.

⁽⁴⁾Available on all the charging stations of the series **TOUCH**.

⁽⁵⁾Supplied only with the charging station model **780**.

⁽⁶⁾Present only on the charging stations **720**.

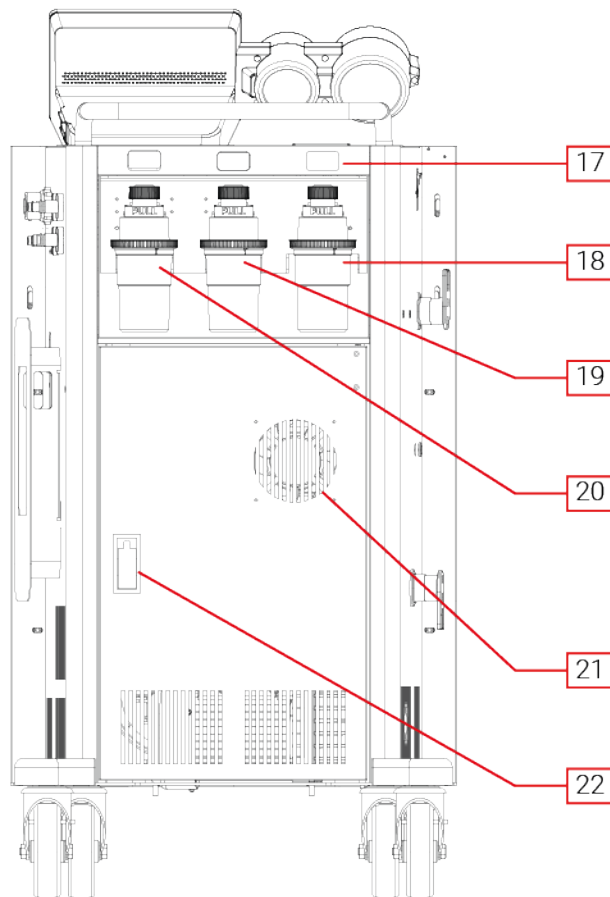

17. Bottle status LED⁸:

- **GREEN:** *bottle inserted correctly*
- **RED:** *bottle removed or not correctly inserted.*

18. **DRAIN:** airtight bottle for recovered oil.⁹

19. **UV:** airtight bottle for UV tracer.¹⁰

20. **OIL PAG/POE:** airtight bottle for specific oil.¹¹

21. Cooling fan

22. Service door

⁽⁸⁾Not available on the charging station model **720**.

^(9,10,11)The **720** charging stations are equipped with standard type bottles.

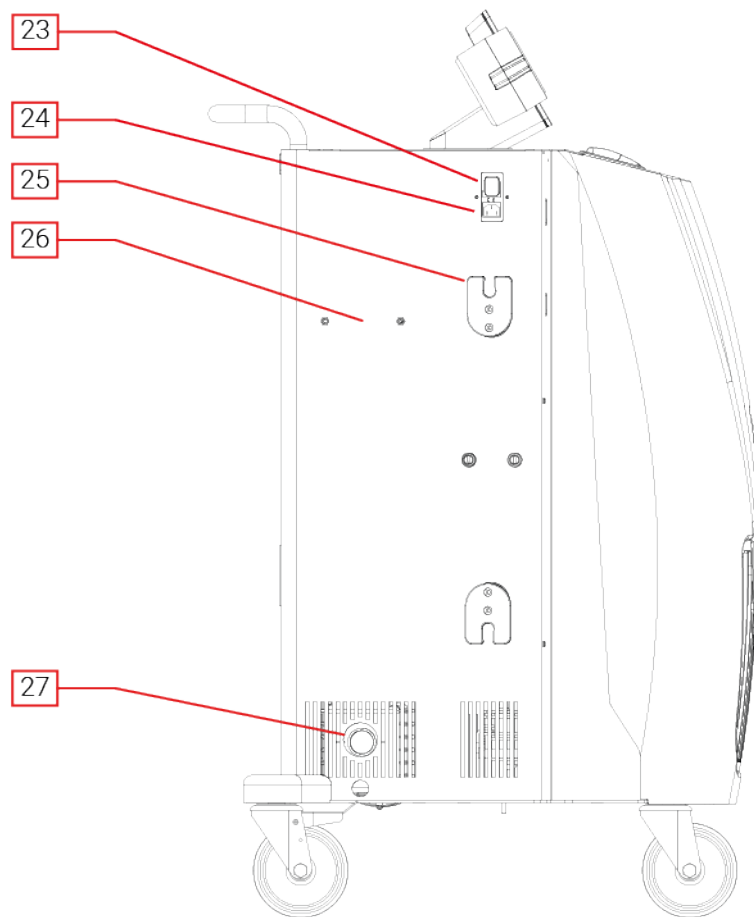

- 23. Main switch
- 24. Power supply cable connector
- 25. Power cable holder
- 26. Fastening holes for FLUSHING KIT
- 27. Pump oil level sight

8.1 Containers

AIRTIGHT CONTAINERS

Available on the charging stations: **760, 760 BUS, 780.**

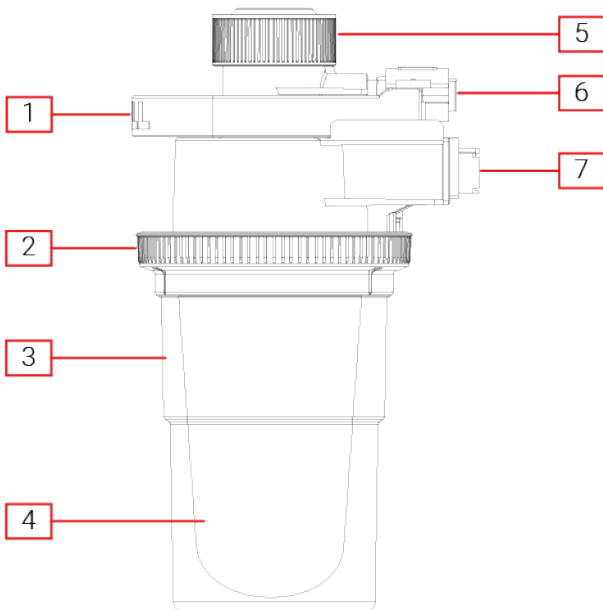

1. *Bottle unlocking handle**
2. *Cup fastening ring*
3. *Cup*
4. *Tank***
5. *Tank cap*
6. *Pneumatic connection*
7. *Electronic connector*

(*) *The color of the unlocking handle indicates what the bottle must be used for.*

(**) *not present in the bottle **DRAIN***

The colors correspond to the following uses:

- **Yellow:** *PAG oil*
- **Green:** *POE oil*
- **Orange:** *UV tracer*
- **Red:** *recovered oil*

STANDARD BOTTLES

Available on the charging stations: **720.**

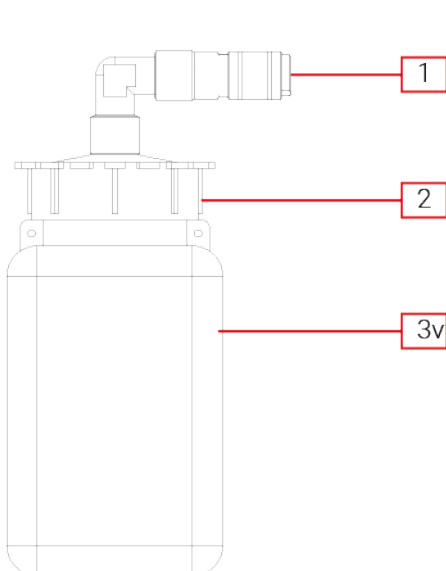

1. *Pneumatic connection*
2. *Tank cap*
3. *Tank*

The standard bottles can be identified by their different capacity:

- **250 ml:** *PAG or POE oil*
- **250 ml:** *UV tracer*
- **500 ml:** *recovered oil*

9 INSTALLATION

This chapter describes the procedures required to install the device properly.

NOTICE



The installation must be performed by qualified personnel only, carefully following the instructions provided in this manual.

The device is provided with the following:

- **GAS KIT** *:
 - *Connections for the quick fittings specific for the version purchased (R134a or R1234yf refrigerant)*
 - *Fastening screws for the fittings*
 - *Stickers that identify the fittings*
 - *Tag indicating the type of refrigerant used*
 - *Pressure clip used to fasten the tag*
- **Technical Manual**: *it contains the description of the device, user instructions to guarantee a correct use and correct maintenance.*
- **USB flash drive**: *it contains the technical and operating manual (user instructions for the equipment)*
- **Power supply cable**
- **TANK FILLING KIT**:
 - *Recharging cylinder hose adapter*
 - *Paper gasket for recharging cylinder hose adapter*
 - *Copper gasket for HP recharging cylinder hose adapter*

(*)Not required for the charging stations:780.

9.1 Unpacking the Device

This chapter gives the instructions for unwrapping/unpacking the equipment.

NOTICE

Perform the described operations with extreme care and on a flat surface to avoid tipping over the device.



Proceed as follows:

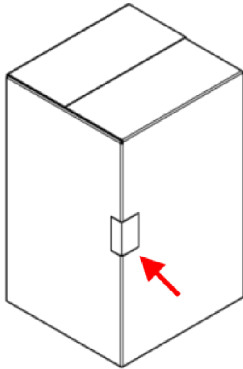

1. Remove the **GAS KIT**.*
2. Remove the cardboard.
3. Remove the bands that fasten the device to the pallet.
4. Remove the device from the pallet.
5. Unlock the wheels.
6. Make sure the device is in good condition and that it has not been tampered with and/or damaged.
7. Make sure no parts are missing.

(*)Not required for the charging stations:780.

9.2 GAS KIT installation

This chapter describes the procedures that need to be carried out in order to install the GAS KIT.

The fittings of the kit have been designed so that they can only be installed on the mini manifolds they have been intended for.

E.g.: the HP quick fitting for the R134a refrigerant can only be installed on its specific manifold and not, for instance, on the LP mini manifold for the R1234yf refrigerant.

When installing the kit remember that:

- **RED:** *always indicates high pressure connection (HP)*
- **BLUE:** *always indicates low pressure connection (LP)*

INFORMATION

The following operations are not required on the charging stations:780.

NOTICE

Carry out the following operations with the equipment switched off and disconnected from the power mains.



Proceed as follows:

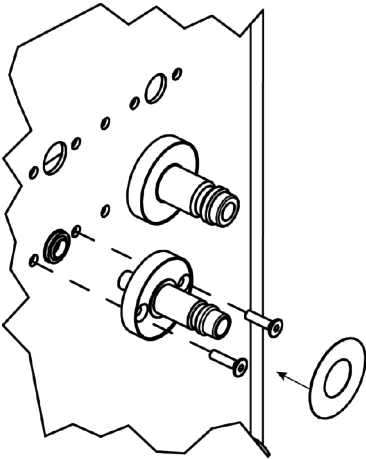

1. Go to the right hand side of the device.
2. Insert the connection for the **HP** quick hose fitting in the appropriate mini manifold.
3. Fasten the connection using the specific screws.
4. Attach the specific adhesive ring to the connection for the **HP** quick hose fitting.
5. Repeat the operations up to here for in order to install the connection for the **LP** quick hose fitting as well.

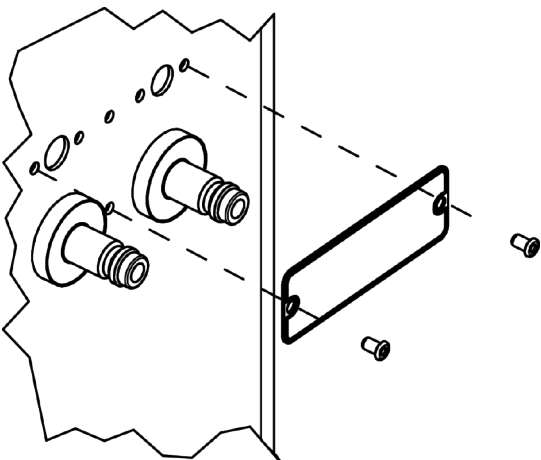

6. Place the tag indicating the gas type above the mini manifold.
7. Fasten the tag using the specific pressure clips.
8. Pull the ferrule on the **HP** quick fitting slightly back and place it on the specific connection.
9. Screw on the ferrule.
10. Repeat the operations up to here for the **LP** quick fitting as well.

10 HANDLING

This chapter describes the operations required to properly handle and position the equipment for use.

10.1 Scale Lock / Unlock

The equipment fitted with a locking /unlocking system for the electronic refrigerant scale are:

- 760
- 760 BUS
- 780

CAUTION

You must always lock the scale before moving the equipment.



NOTICE

You must always unlock the scale before using the equipment.



Proceed as follows:

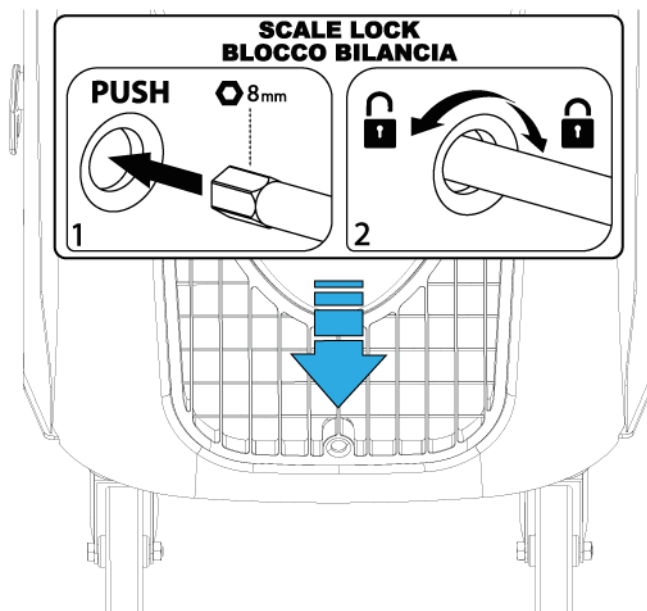

1. Go to the front of the device.
2. Locate the scale locking / unlocking control.

- **Locking the scale:** *push and turn the locking/unlocking control clockwise using the specific wrench.*
- **Unlocking the scale:** *push and turn the locking/unlocking control counter-clockwise using the specific wrench.*

10.2 Moving the Device

The equipment must be moved on its own wheels.

CAUTION



The equipment was specifically designed and created to lower the center of gravity, so the heavier components were placed on the bottom; however it was not possible to completely eliminate the risk of tipping over.

Do not handle the equipment on excessive slopes.

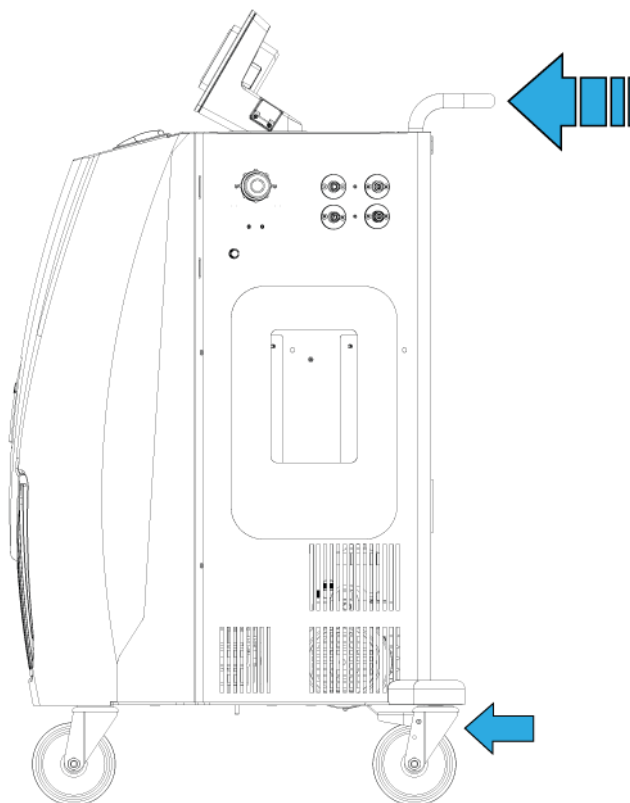

Proceed as follows:

1. *Disconnect the service hoses from the vehicle's A/C system.*
2. *Disconnect the power cable from the mains.*
3. *Lock the refrigerant scale.*
4. *Unlock the wheels (if required).*
5. *Push the cart using the specific handle located on the back of the equipment.*

10.3 Positioning

The device must be placed near the A/C system that must be checked; make sure it is on a flat surface and in an appropriate environment, as specified in the safety regulations in this manual.

Once the device has been positioned, we suggest locking the wheels with the specific mechanical brakes the wheels are equipped with.

NOTICE

Positioning the equipment on slopes, even though their inclination excludes the risk of tipping over, may interfere with proper equipment operation.



CAUTION

Position the equipment so that the main switch can be always reached easily.



11 POWER SUPPLY

The equipment is powered by the mains through a specific power cable.

The equipment must be connected to the mains through the supplied specific power cable; respect the applicable voltage, frequency and power values.

The voltage, frequency and power values that can be applied can be found on the tag located near the main switch.



CAUTION

**The mains plug must be used to disconnect from the mains.
Do not position the equipment so that it becomes difficult to disconnect it from the mains.**

Do not use extension cords to power the equipment.

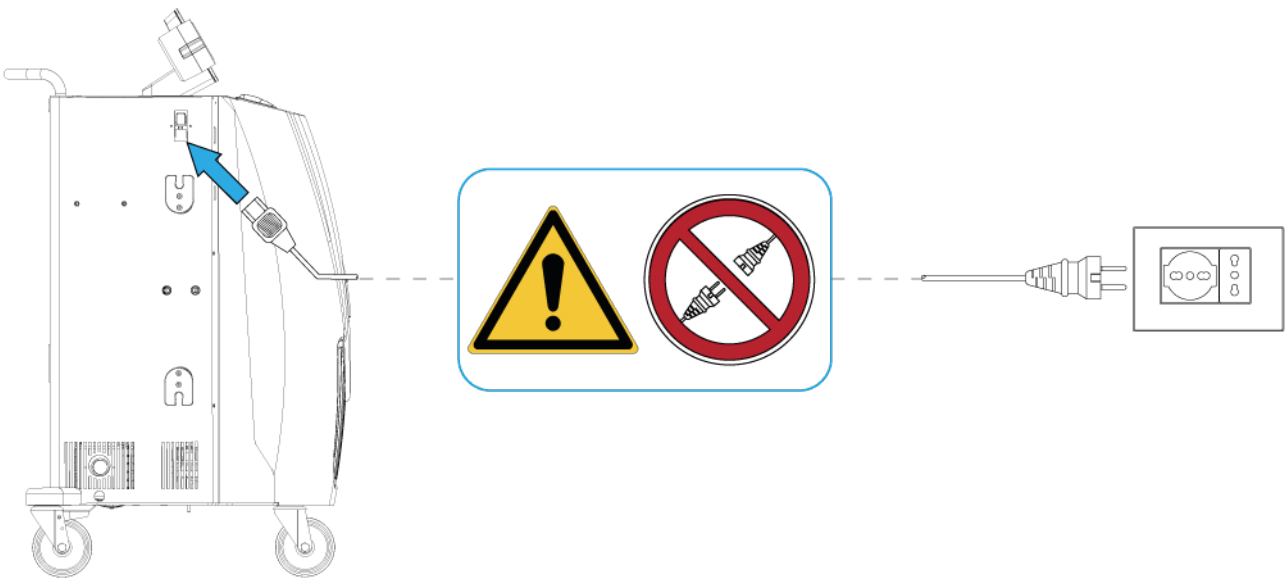

Proceed as follows:

1. Go to the left side of the equipment.
2. Connect the power supply cable to the specific connector.
3. Connect the power cable to the mains via a grounded socket.

12 POWER ON/OFF

The equipment can be powered on and off using the main switch located on the left side of the charging station.

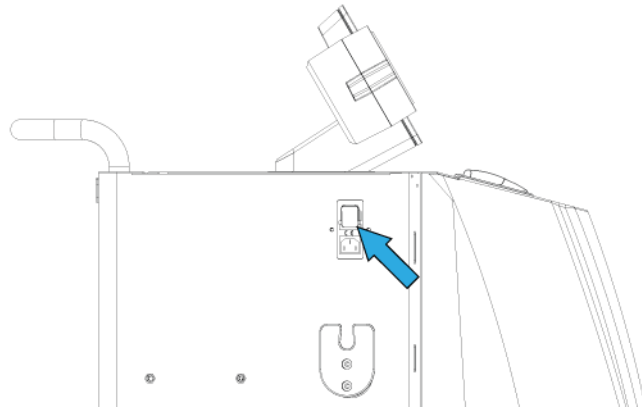

To turn on the equipment, set the main switch to the **I** (ON) position.

To turn off the equipment, set the main switch to the **O** (OFF) position.

WARNING

Do not disconnect the equipment from the mains by unplugging the power cable either from the equipment or from the socket.



12.1 Stopping the Equipment for Long Periods

If you need to stop the equipment for a long period of time, follow the instructions below.

Proceed as follows:

1. *Disconnect the equipment from the mains.*
2. *Place the provided cover over the equipment.*
3. *Store the equipment in a safe place, not exposed to outside weather conditions.*

13 SETTING UP BEFORE USING

This chapter describes the maintenance operations required for setting up the equipment.

13.1 How to Fill the Bottles

The bottles provided with the device are empty upon delivery.
The **PAG/POE OIL** and **UV** bottles must be filled before use.

NOTICE

Fill the oil bottle with the correct type of oil (PAG/POE).



AIRTIGHT BOTTLES

In order to fill an air-tight bottle proceed as follows:

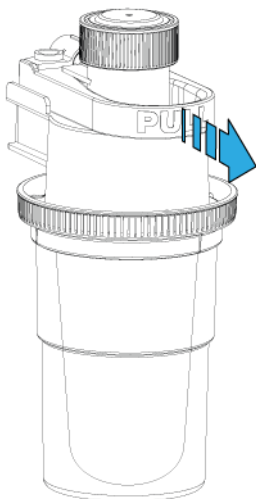

1. Remove the desired bottle by pulling the unlocking handle.
2. Unscrew the tank cap.
3. Fill the bottle with oil/UV tracer.
4. Screw the tank cap back on.
5. Reinsert the bottle.

STANDARD BOTTLES

To fill a standard bottle proceed as follows:

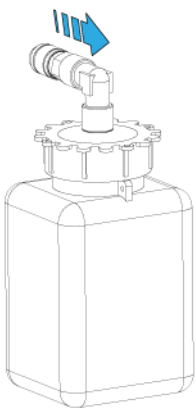

1. Remove the desired bottle by slightly pulling back the ferrule on the pneumatic coupler.
2. Unscrew the tank cap.
3. Fill the bottle with oil/UV tracer.
4. Screw the tank cap back on.
5. Reinsert the bottle by slightly pulling back the ferrule on the pneumatic coupler.

13.2 How to Fill the Internal Tank

The internal tank in the device is empty upon delivery.

NOTICE

You must carefully read and understand this Operating Manual to perform the provided instructions correctly.



Proceed as follows:

1. Turn on the equipment.
2. Launch the software function for the internal tank filling by selecting **ADDITIONAL FUNCTIONS** in the menu.

NOTICE

If you are working with the 780 charging station, make sure to select the specific filling function for the gas you intend to refill.



3. Follow the on-screen instructions.



For more information see the software's Operating Manual.



13.3 How to Load the Paper into the Printer

The **780** stations are provided with a thermal printer.

INFORMATION

The printer is an accessory that can be purchased separately and installed also on the other charging station models.

The buttons on the printer have the following functions:

Key	Name	Function
	PAPER FEED	It allows the paper to come out.
	ON/OFF	It allows setting the printer on on-line/off-line mode.

The printer is equipped with a green LED that indicates its status:

- **Solid on:** *printer on-line*
- **Flashing:** *the printer is off-line or there is no paper*
- **Off:** *printer off-line*

The printer is automatically on-line when the equipment is switched on.

Press  if the status LED indicates that the printer is off-line.

Using the printer it is possible to print a report containing the following information:

- *company data*
- *vehicle data*
- *customer data*
- *operations carried out*



For more information see the software's Operating Manual.

You must fill the printer with paper before use.

Proceed as follows:

1. Lift the paper compartment opening lever lightly until the corresponding cover locks.
2. Place the paper roll into the specific compartment.
3. Close the compartment by pressing lightly on the cover and leaving a slip of paper sticking out.

4. Press  to make sure the paper has been inserted correctly.
5. Repeat the operations indicated above if the paper does not come out.

13.4 Initial Configuration

The first time the equipment is turned on, it requires you to select the software's display language.

Once selected, the configuration wizard is started.

This procedure allows you to:

- *configure the communication between the equipment and the workshop's Wi-Fi network;*
- *set the system date and time;*
- *enter the workshop data;*
- *select the type of refrigerant used;*
- *etc.*



For more information see the software's Operating Manual.

13.4.1 Demo Mode

The equipment includes a demo mode (**Demo**).

The equipment can be used in **Demo** mode for a **maximum of 15 power on-power off cycles**.

INFORMATION

The equipment locks automatically at the end of the cycle and can no longer be used.

To unlock the equipment, you must activate the product online. Alternatively, the equipment can be activated manually, requesting the unlock code via TEXA Service Code.

14 COMMUNICATION

The charging station's controller integrates the following:

- *Wi-Fi module*
- *Bluetooth module*

The charging stations also have a USB connector.

14.1 Wi-Fi

The Wi-Fi module built into the controller allows connecting the charging station to the workshop's Wi-Fi network.

The Wi-Fi connection to the workshop's network allows the following:

- *connection to the printers in the network, to print reports in A4 format;*
- *download of updates;*
- *remote assistance;*
- *connection with smartphones in which the KONFORT Mobile app is installed.*

The connection to the Wi-Fi network must be configured through the software functions.

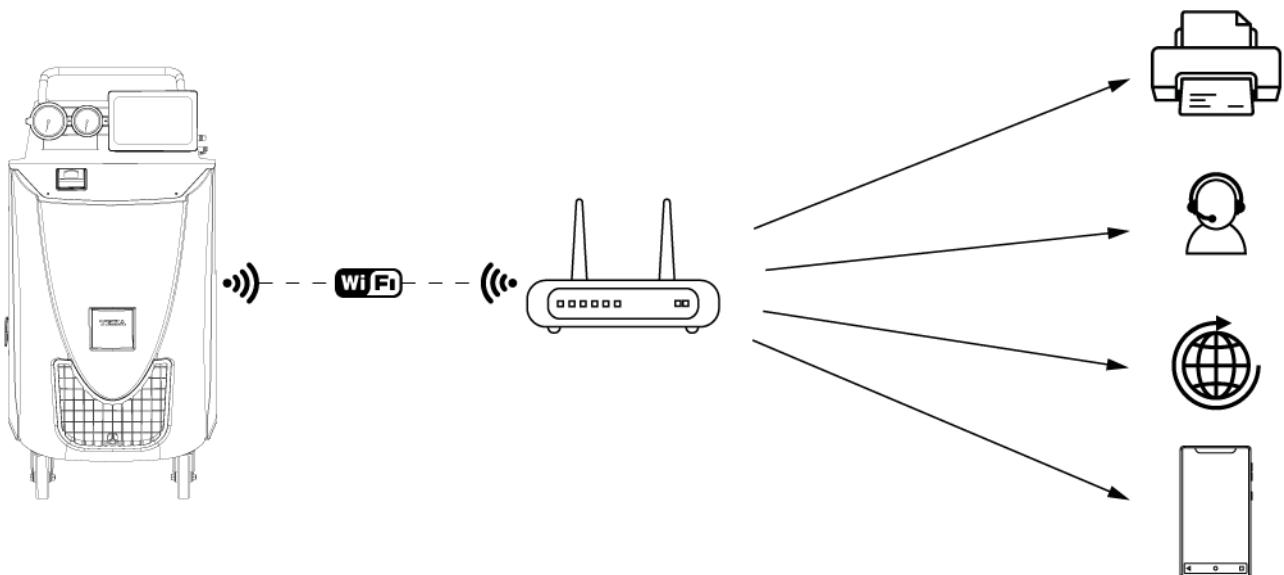

Proceed as follows:

1. *Turn on the charging station.*
2. *Access the communication configuration functions.*
3. *Start the configuration of the Wi-Fi communication.*
4. *Follow the on-screen instructions.*

INFORMATION

In order to print in A4 format, the charging station and the printer must be connected to the same Wi-Fi network.

To download updates and use the remote assistance functions, the Wi-Fi network must have an Internet connection.



For more information see the software's Operating Manual.

14.2 Bluetooth

The Bluetooth module built into the controller allows connecting the charging station to accessories such as:

- *A/C system efficiency testing kit;*
- *diagnostic interfaces;*
- *ozone sanitizer;*

The Bluetooth connection must be configured through the software functions.

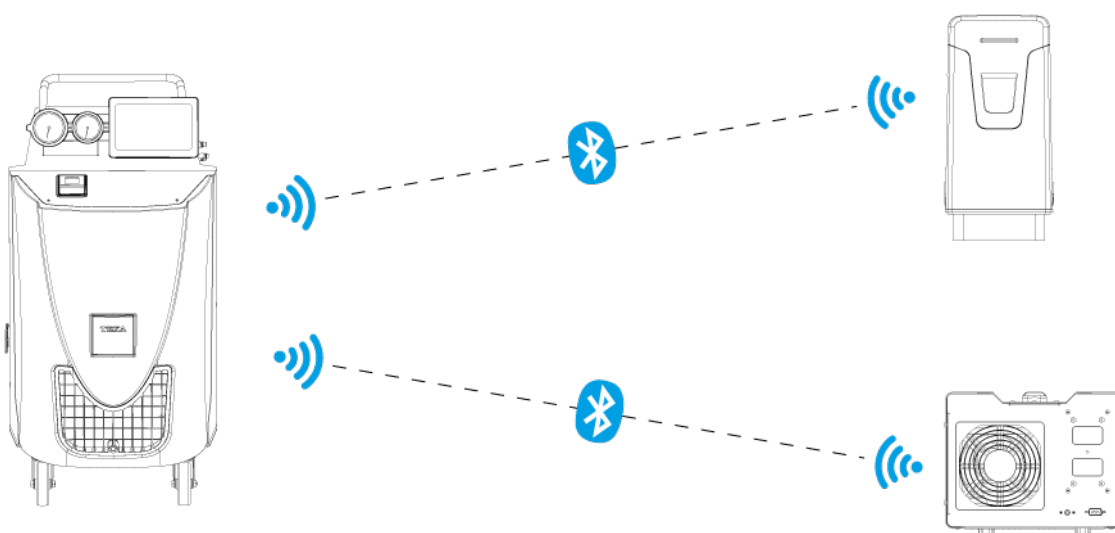

Proceed as follows:

1. *Turn on the charging station.*
2. *Access the communication configuration functions.*
3. *Start the configuration of the Bluetooth communication.*
4. *Follow the on-screen instructions.*



For more information see the software's Operating Manual.

14.3 USB

The USB connector located on the right side of the charging station allows you to:

- *access the manuals contained in the provided USB flash drive;*
- *back up the reports of the services carried out and of the entire system;*
- *install updates in off-line mode if the workshop does not have a Wi-Fi network with an Internet connection.*

NOTICE

Do not connect devices to the charging station via the USB connector.

15 User Instructions

The software in the charging stations allows selecting the vehicle to work on choosing among the ones in the database and launching all the functions required in order to recharge and check the vehicle's A/C system.

CAUTION

Monitor the equipment at all times during the operating phases, making sure to wear appropriate personal protective equipment.



Proceed as follows:

1. *Place the charging station near the vehicle you wish to work on.*
2. *Power the charging station and turn it on.*
3. *Select the type of service that must be carried out.*
4. *Follow the on-screen instructions.*

The software provides on-screen indications required to carry out the various operations and warns if errors occur during the phases.



For more information see the software's Operating Manual.

16 UPDATING

The firmware and software can be updated via:

- *Wi-Fi*
- *USB*

NOTICE

Keep the charging station on and powered as long as needed for the update to complete.

The update via Wi-Fi requires connecting the charging station to the Internet through the workshop's Wi-Fi network.

If the workshop does not have a Wi-Fi network with access to the Internet, the update can be performed off-line using the **KONFORT TOUCH UPDATER** software.

This software allows downloading the software and/or firmware update pack from the Internet and copy it into a USB flash drive.

In this case, you need to use a USB flash drive with at least 8 GB of available space to download the update files.

INFORMATION

We recommend using the provided USB flash drive.

Proceed as follows:

1. *Download the software from the website: <https://www.texa.com/download>*
2. *Install the software on a PC equipped with an Internet connection.*
3. *Connect the provided USB flash drive to the PC.*
4. *Launch the software.*
5. *Wait for the update to be downloaded onto the USB flash drive.*
6. *Disconnect the USB flash drive from the PC.*
7. *Turn on the charging station.*
8. *Connect the USB flash drive to the charging station.*
9. *Launch the software update function.*
10. *Wait for the update to complete.*



For more information see the software's Operating Manual.

17 MAINTENANCE

This chapter describes the maintenance operations required for the device.

CAUTION

Carefully follow the instructions provided in this manual.
Only use original spare parts or approved by TEXA.



INFORMATION

For further help, contact your Retailer or the Technical Assistance service.

You can see the list of authorized retailers at the following address: <https://www.texa.com/sales-network>

17.1 Ordinary Maintenance

Scheduled maintenance is made up of a series of operations that must be carried out periodically.

Specific messages will appear on the screen each time a maintenance operation has expired and needs to be carried out.

Maintenance operation	Frequency
Dehydrator Filter Replacement	When prompted by the device.
Mechanical Filter Replacement	Along with the dehydrator filter replacement.
Vacuum pump oil replacement	When prompted by the device.
Printer paper replacement*	each time the paper runs out.

(*) Only for **780** charging stations or for charging stations on which the optional printer kit has been installed.

WARNING

The maintenance operations that require you to open the service door / bulkheads and to remove parts of the equipment must be carried out with the equipment switched off.



Proceed as follows:



1. Go behind the device.
2. Locate the service door.
3. Lift the opening lever.
4. Turn the lever clockwise.
5. Open the service door.

17.1.1 Dehydrator Filter Replacement

The filter must be replaced **when you are prompted to do so by the device.**

CAUTION

There could be accidental refrigerant leaks while replacing the filter.



Carefully follow the instructions provided below to avoid the refrigerant from getting into the atmosphere.



Wear appropriate protective glasses and gloves while replacing the filter.



You must carefully read and understand this Operating Manual to perform the provided instructions correctly.

Before replacing the filter you must reset the "**filter counter**" using the appropriate software function.

Proceed as follows:

1. Switch on the equipment.
2. Select **ADDITIONAL FUNCTIONS** -> **RESET COUNTER** -> **FILTER REPLACEMENT**.
3. Follow the on-screen instructions.

CAUTION

Do not open the equipment's service door until it is specifically indicated on the screen.



After resetting the counter you can replace the filter.

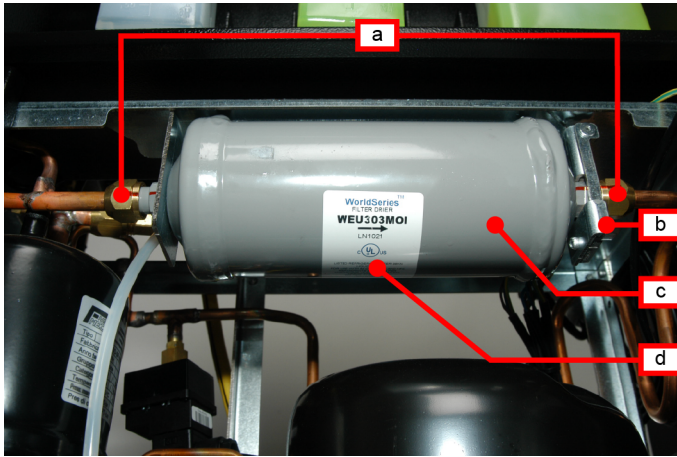

- a) Screw nuts for the filter
- b) Blocking clip
- c) Filter
- d) Arrow indicating the direction of the flow

Proceed as follows:

1. Access the components inside the charging station.
2. Open the filter's blocking clip.
3. Unscrew the 2 fixing nuts on the filter dryer using the specific hexagonal wrenches no. 16 and no. 19.
4. Remove the filter by slipping it from the right side.
5. Check that the sealing O-rings are in good condition and replace them if necessary.
6. Install the new filter screwing the fixing nuts with a tightening torque of approximately 17 N m.

NOTICE

The arrow that indicates the flow in the filter must point towards the right.



7. Close the filter's blocking clip.
8. Close the recharging station.
9. Complete the operation following the instructions on the screen.

17.1.2 Mechanical Filter Replacement

The mechanical filter when the dehydrator filter is replaced.

CAUTION

Follow the same safety precautions indicated in the **Dryer Filter Replacement** chapter.

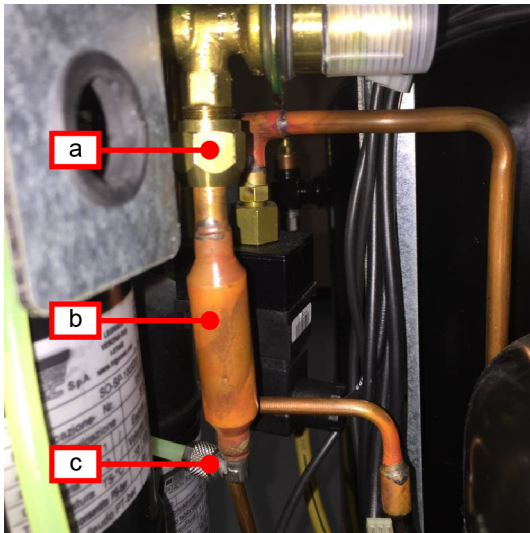

The mechanical filter is located **behind** the filter dryer.

- a) *Constant expansion valve connection - mechanical filter*
- b) *Mechanical filter.*
- c) *Rilsan pipe connection - mechanical filter.*

Proceed as follows:

1. *Open the service door.*
2. *Remove the dehydrator filter (see **Dehydrator Filter Replacement** chapter).*
3. *Locate the mechanical filter.*
4. *Unscrew the Rilsan pipe connection - mechanical filter, using a proper spanner wrench.*
5. *Unscrew the constant expansion valve connection - mechanical filter, using a spanner wrench no. 19.*
6. *Remove the filter.*
7. *Mount an O-ring on the new filter on the side of the constant expansion valve connection.*
8. *Remount the filter using the specific tools and tightening with a torque of approximately 17 Nm.*

17.1.3 How to Replace the Vacuum Pump Oil

The oil in the vacuum pump must be replaced **when you are prompted to do so by the device.**



You must carefully read and understand this Operating Manual to perform the provided instructions correctly.

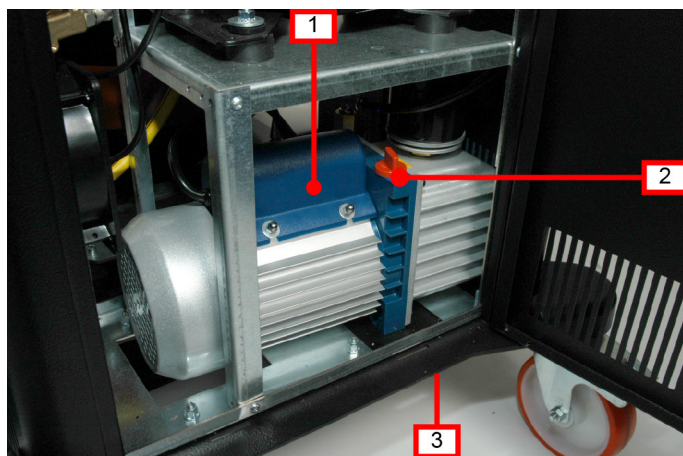

1. Vacuum pump
2. Filler cap
3. Oil drain cap*
4. Pump oil level inspection

(*The oil drain cap is placed under the equipment, near the pump oil level sight.

Proceed as follows:

1. Disconnect the device from the power mains.
2. Unscrew the oil drain cap.
3. Wait for all the oil to drain from the pump.

NOTICE

Collect the recovered oil and dispose of it according to the regulations in force.



4. Screw the oil drain cap on.
5. Unscrew the oil filler cap.
6. Fill with new oil.

INFORMATION

The correct pump oil level is approximately half of the level sight and the total amount to refill is approximately 370 ml.

7. Screw the oil filler cap on.
8. Reset the **Pump Time Counter Reset.**

17.1.4 Replacing the Paper in the Printer

Follow the instructions provided in the chapter **Replacing the Paper in the Printer.**

17.2 Periodical Checks

In order to guarantee proper operation of the device we recommend checking on a regular basis the parts that are the most subject to wear.

Parts subject to wear	Check
Service hoses	Make sure there are no cuts, scratches or bulges.
Quick fittings	Make sure there are no signs of wear and that the hoses do not harden during use. Make sure the service hoses are connected properly. Make sure there are no cuts or scratches on the O-rings.
Oil and UV bottles	Make sure they are clear and not damaged.
Wheels	Make sure the brakes are working properly.
Power supply cable	Make sure there are no cuts, scratches or burns.

17.3 Periodical Safety Checks

In order to guarantee the correct operation of the device, carry out periodical checks on the safety devices.

The safety valve and safety pressure switch must be visually checked to verify that they are not damaged in order to guarantee that they are working properly.

WARNING



A periodic inspection of the operation of the safety devices (Safety Pressure Switch and Safety Valve) and of the integrity of the refrigerant liquid receiver must be carried out at intervals defined by the national regulations in force in the country in which the equipment is being used.

18 TECHNICAL FEATURES

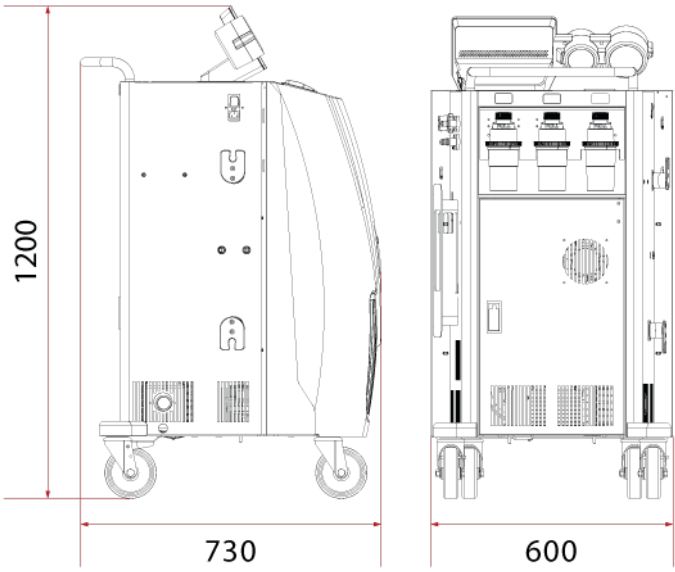

Builder	TEXA S.p.A.			
Series	TOUCH			
Model	720	760	760 BUS	780
Display	10.1" TFT; 1024x600 pixel; 400CD Anti-glare			
GPU	Qualcomm© Adreno™ 308 Graphics Processing Unit (GPU) with 64-bit addressing			
Touch	Capacitive touch panel, 12C interface			
CPU	<ul style="list-style-type: none"> • SC200R Series Snapdragon QCM2150 Quad-core ARM Cortex-A53 64-bit CPU @ 1.3 Ghz • STM32F103 - ARM Cortex M3 32-bit CPU 			
RAM	2 GB LPDDR3			
Hard disk	16 GB eMMC			
Operating system	Android 10.0			
Audio peripheral devices	1 speaker CES-703116-28PM 8ohm 2W			
Wi-Fi	802.11a/b/g/n, 150 Mbps, STA/AP/P2P 2402-2480 MHz 5 Ghz			
Bluetooth	2.1+EDR/3.0/4.1 LE/4.2 BLE 2400-2483,5 MHz			
RF power	20 dBm			
I/O peripheral devices	USB 2.0 x1			
Primary battery	3 V CR2032			
Secondary battery	NiMh 2,4 V - 600 mAh			
Fluid / Group	R134a / 2 R12324yf / 1			
Electronic refrigerant scale (Precision) [g]	± 10			
Electronic oil and UV tracer scales (Resolution) [g]	--	1	1	1
Pressure transducer	KI. 1.0			

High pressure gauge [mm]	Ø 100			
Low pressure gauge [mm]	Ø 80			
Tank capacity [kg]	12	20	30	2 x 12
Service pipes' length [m]	3			
Filter assembly	1 combined filter + mechanical filter			
Compressor (airtight) [cc]	12	12	21	12
Vacuum pump	100 l/m, double stage, final pressure 0,03 mBar	100 l/m, double stage, final pressure 0,03 mBar	146 l/m, double stage, final pressure 0,03 mBar	100 l/m, double stage, final pressure 0,03 mBar
Ambient temperature sensor (Resolution) [°C]	1			
Tilt sensor (Resolution on the 3 axes)	--	1°	1°	1°
Refrigerant purity [kg]	150 (SAE J2099)			
Recovery efficiency	> 95 % (SAE J2788 / SAE J2843)			
Maximum operating pressure (PS) [bar]	20			
Safety device calibration [bar]	20			
Power supply voltage [V] (Only for Japan)	230	230 (100)	230	230 (100)
Frequency (Hz) : (Only for Japan)	50	50 (50 / 60)	50	50 (50 / 60)
Power [W]	770	770	770	990
Operation temperature (TS) [°C]	5 ÷ 40			

<p>Storing temperature [°C]</p>	<p>- 25 ÷ 60</p>			
<p>Dimensions [mm]</p>	 <p>The image contains two technical drawings of a mobile device. The left drawing is a side view showing a height dimension of 1200 mm and a width dimension of 730 mm. The right drawing is a front view showing a depth dimension of 600 mm. The device is a rectangular unit on wheels with various ports and components on its top and front panels.</p>			
<p>Weight [kg]</p>	<p>101</p>	<p>110</p>	<p>123</p>	<p>121</p>

19 DATA PLATE

Every single device is accompanied by an identification data plate just as the one in the example provided below:

			
Via I Maggio,9 31050 Monastier di Treviso (TV) ITALY MADE IN ITALY		 SN: 12345678490	
Modello Type	K7--R	Alim. Volt	230V
Fluido/Gruppo Fluid/Group	R134a / 2 R1234yf / 1	Potenza assorb. Power Absorp.	770W
Carico max fluido Max refrigerant charge	12 Kg	Anno Year	2021
PS 20 bar	TS 5/40° C	Taratura disposit. sicurezza	20 bar
<small>Contiene gas fluorurati ad effetto serra disciplinati dal Protocollo di Kyoto Contains fluorinated greenhouse gases covered by the Kyoto Protocol</small>			

Where:

- **PS:** *maximum operating pressure;*
- **TS:** *operating temperature.*

20 HYDRAULIC DIAGRAMS

KONFORT 720 TOUCH

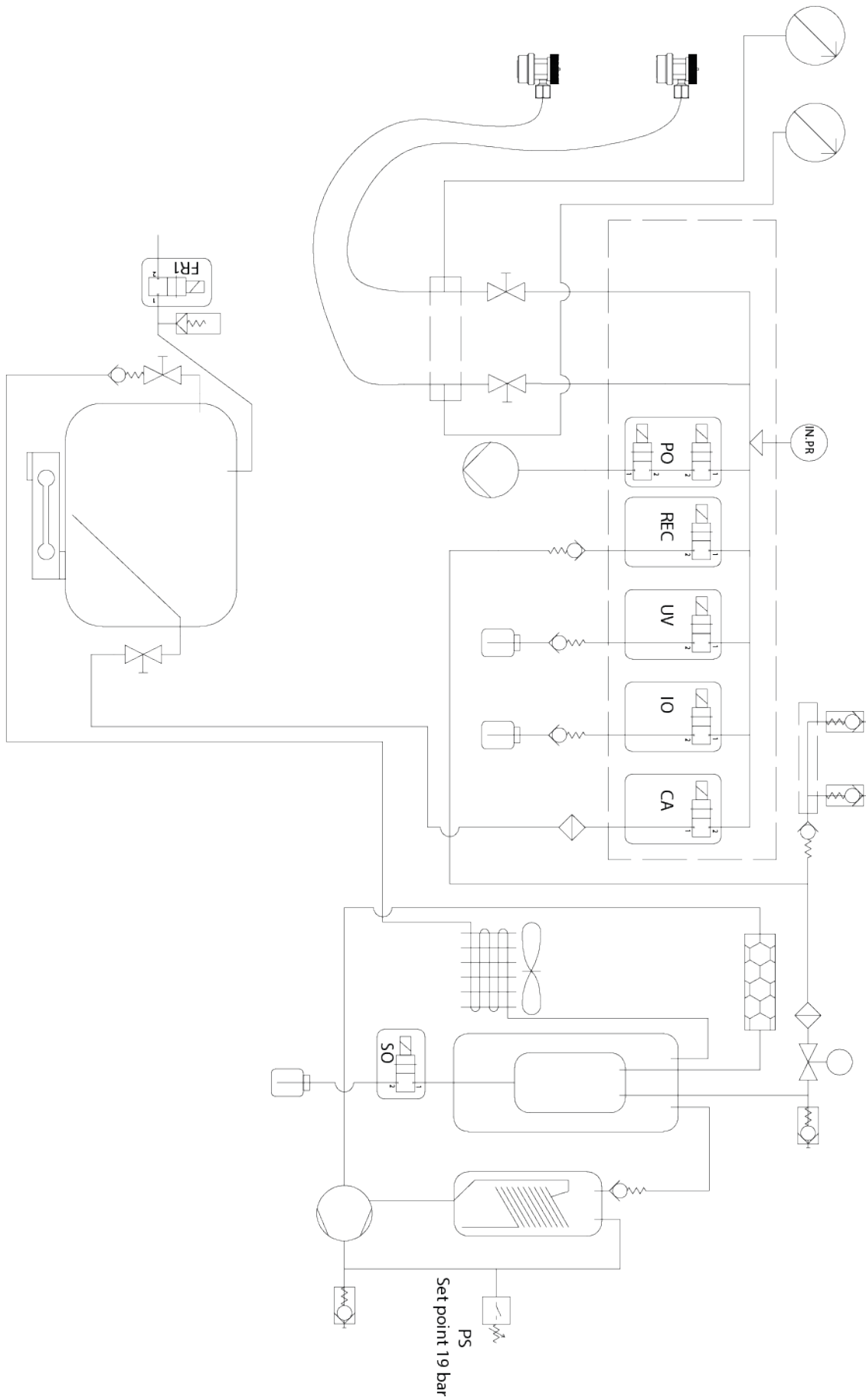

KONFORT 760 TOUCH

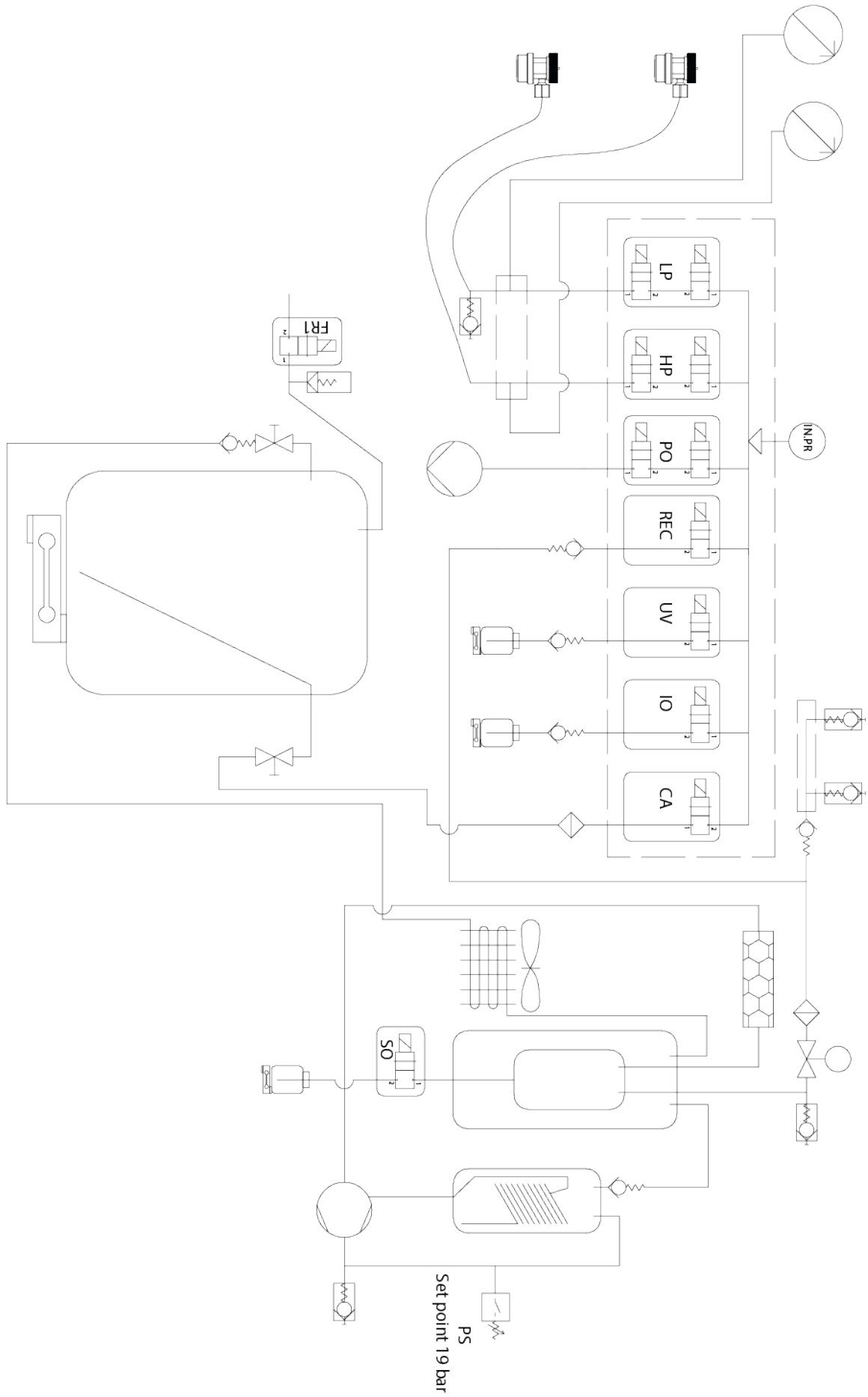

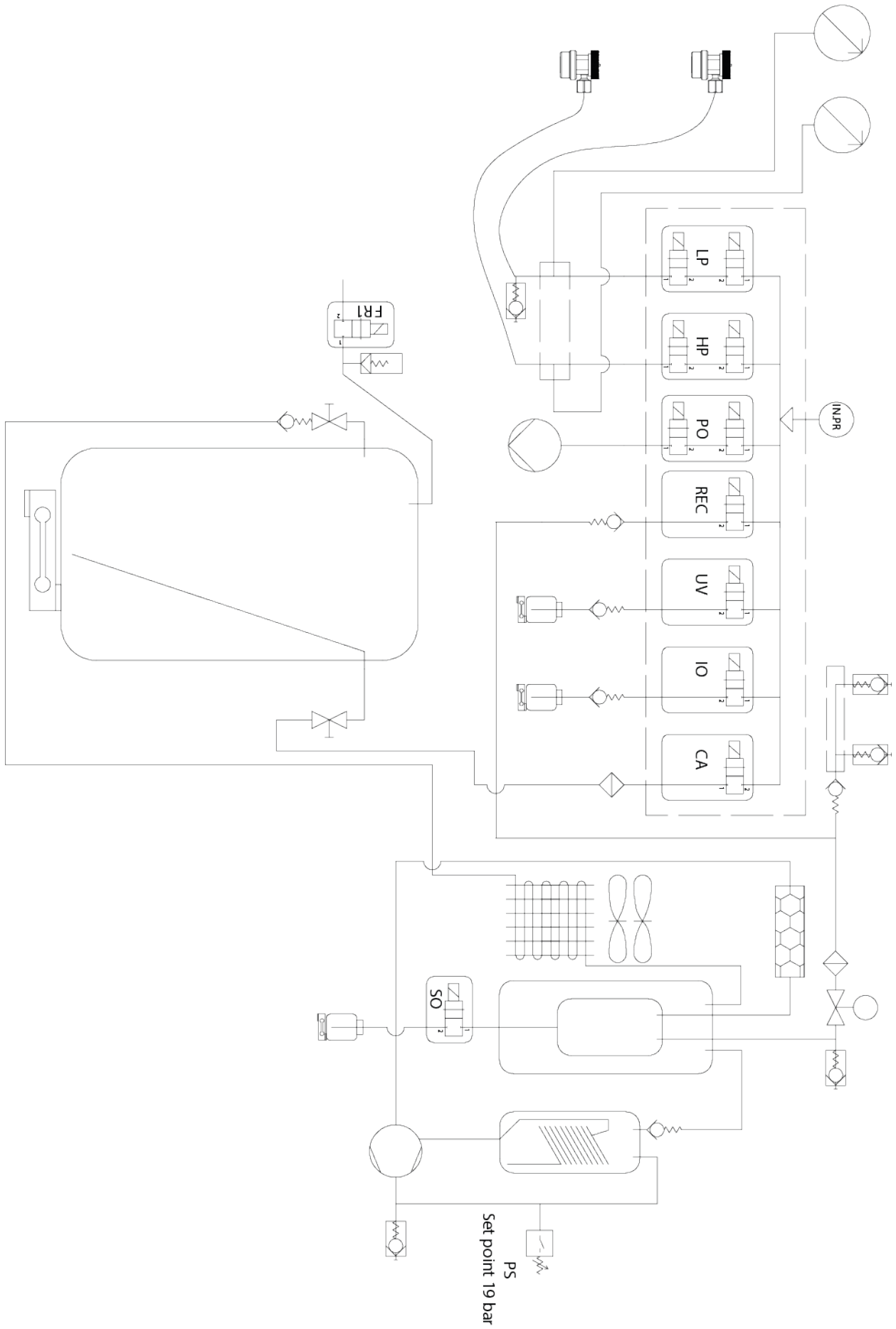

KONFORT 780 TOUCH

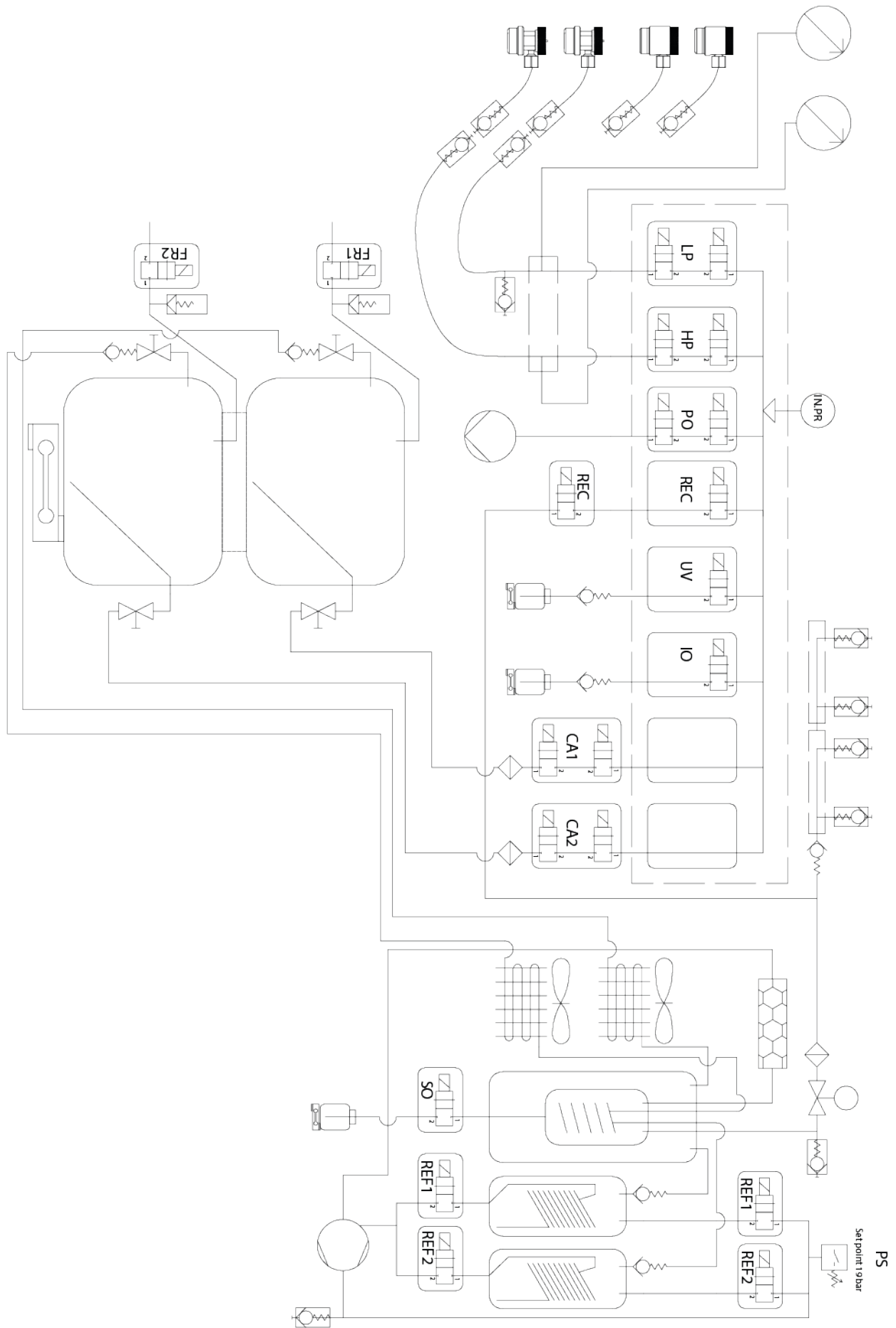

21 DISPOSAL

Below you will find information on how to properly dispose of the device.

21.1 How to Dispose of the Device

To dispose of the device proceed as follows:

1. *Ask assistance personnel to collect all the refrigerant in the internal circuit, making sure the internal storage tank is emptied as well.*
2. *Take the equipment to a waste disposal center.*



For more information regarding the disposal consult the pamphlet provided with the device.

21.2 How to Dispose of the Recycled Materials

The refrigerants that cannot be reused must be taken to the supplier of the refrigerant so it can be disposed of.

The oils removed from the systems must be taken to used oil collection centers.

22 LEGAL NOTICES

TEXA S.p.A.

Via 1 Maggio, 9 - 31050 Monastier di Treviso - ITALY

Tax Code - Company Register of Treviso ID No. - VAT No.: 02413550266

Single-shareholder company subject to the direction and coordination activities of Opera Holding S.p.A.

Paid-up share capital 1,000,000 € - R.E.A. (Economic Administrative Index) No. 208102

Legal Representative Bruno Vianello

Phone +39 0422.791.311

Fax +39 0422.791.300

www.texa.com

For information regarding the legal notices, please refer to the **International Warranty Booklet** provided with the product.