

IR Calibration Target



Rev.

TEXA

ENGLISH.....5

SUMMARY

1 Revision of the Manual.....	5
INTRODUCTION.....	6
2 LEGEND OF THE SYMBOLS USED.....	7
3 SAFETY RULES.....	8
3.1 Glossary.....	8
3.2 General Rules.....	8
3.3 Operator Safety.....	9
3.4 Device Safety.....	9
4 ENVIRONMENTAL INFORMATION.....	11
5 NORMATIVE INFORMATION.....	12
6 IR CALIBRATION TARGET.....	13
7 DESCRIPTION.....	14
8 TECHNICAL FEATURES.....	15
9 PRELIMINARY OPERATIONS	17
10 POWER SUPPLY.....	19
11 POWER ON/OFF.....	20
12 PERFORMING A TEST / CALIBRATION.....	21
13 MAINTENANCE.....	22
13.1 Fuse Replacement.....	22
14 TROUBLESHOOTING.....	24
15 LEGAL NOTICES.....	25

1 Revision of the Manual

This document is the technical manual for the product:IR CALIBRATION TARGET

Document Review Number:03

Date of Issue:20/07/2023

INFORMATION



Read this manual before using the product.

Read the documents carefully whenever the General Risk symbol is shown.

INTRODUCTION

Dear Customer,

We would like to thank you for choosing a TEXA product for your workshop.

We are certain that you will get the greatest satisfaction from it and receive a great deal of help in your work.

Please read through the instructions in this manual carefully and keep it for future reference.

Reading and understanding the following manual will help you to avoid damage or personal injury caused by improper use of the product to which it refers.

TEXA S.p.A reserves the right to make any changes deemed necessary to improve the manual for any technical or marketing requirement; the company may do so at any time without prior notice.

This product is intended for use by technicians specialised in the automotive field only. Reading and understanding the information in this manual cannot replace adequate specialised training in this field.

The sole purpose of the manual is to illustrate the operation of the product sold. It is not intended to offer technical training of any kind and technicians will therefore carry out any action under their own responsibility and will be accountable for any damage or personal injury caused by negligence, carelessness, or inexperience, regardless of the fact that a TEXA S.p.A. tool was used for the actions based on the information within this manual.

Any additions to this manual, useful in describing the new versions of the program and new functions associated to it, may be sent to you through our TEXA technical bulletin service.



















This manual should be considered an integral part of the product to which it refers. In the case it is resold the original buyer is therefore required to forward the manual to the new owner.





Reproduction, whole or in part, of this manual in any form whatsoever without written authorization from the producer is strictly forbidden.

The original manual was written in Italian, every other language is a translation of the original manual.

© **copyright and database rights 2016.** The material contained in this document is protected by copyright and database rights. All rights reserved according to law and international agreements.

2 LEGEND OF THE SYMBOLS USED

	Toxic material hazard		Risk of crushing hands
	Explosive material hazard		Floor level obstacle warning
	Electric shock hazard		Laser beam hazard
	Electromagnetic field hazard		Low temperature danger - freezing
	Flammable material hazard		General Risk
	Hot surface hazard		Obligation to read the instructions
	Corrosive substance hazard		Safety glasses required
	Risk of noise level above 80 dB(A)		Protective gloves required
	Moving Parts Risk		Disconnect mains plug from electrical outlet

	This is not a safety symbol. It indicates a hazardous situation which, if not avoided, will result in serious permanent injury or death.
	This is not a safety symbol. It indicates a hazardous situation which, if not avoided, may result in serious permanent injury or death.
	This is not a safety symbol. It indicates a hazardous situation which, if not avoided, may result in minor injury.
	This is not a safety symbol. It indicates a hazardous situation which, if not avoided, may result in material damage.
	This is not a safety symbol. It indicates important information.

3 SAFETY RULES

The technology used for the design and manufacturing control of **IR CALIBRATION TARGET** makes it a reliable, simple and safe device to use.

The personnel in charge of using the diagnostic tools are required to follow the general safety rules and to use the **IR CALIBRATION TARGET** device for its intended use only and to carry out the maintenance as described in this manual.

All the requirements based on the following must be assessed and applied:

- *Labour inspectorate.*
- *Trade associations.*
- *Vehicle manufacturers.*
- *Anti-pollution regulations.*

3.1 Glossary

Operator:qualified person in charge of using the device.

Device:IR CALIBRATION TARGET

INFORMATION

The definition of "operator" cannot be applied to minors or to people with reduced physical, sensory or mental capabilities or without any experience or knowledge required.

3.2 General Rules



The operator must have carefully read and fully understood all the information and instructions in the technical documents provided with the tool.If the operator is not able to read this manual, the operating instructions and safety indications must be read and discussed in the operator's native language.

- *The operator that works on vehicles must have basic qualifications and knowledge of mechanics, automotive engineering, vehicle repairing and of the potential dangers that may arise during self-diagnosis operations.*
- *The operator must be completely clear-headed and sober when using the tool; taking drugs or alcohol before or when operating the tool is strictly forbidden.*
- *The operator must follow all the instructions provided in the technical documents.*
- *The operator is required to wear adequate Personal Protective Equipment (PPE) at all times when using the tool.*
- *The operator must monitor the device during the operating phases wherever this is possible in compliance with the safety measures indicated below.*
- *The operator must periodically check the electrical connections of the device, making sure they are in good condition and immediately replacing any damaged cables.*
- *The operator must periodically check the parts that are subject to wear and replace them if necessary, using only original spare parts or spare parts approved by the manufacturer.*
- *The operator must stop using the device immediately should any failure occur, and promptly contact the technical assistance.*
- *Contact your retailer for extraordinary maintenance operations.*

- Do not remove or damage the labels and the warnings on the tool; do not in any case make them illegible.
- Do not remove or tamper with any safety devices the tool is equipped with.

3.3 Operator Safety

NOTICE



The device was designed and built to be stable and solid once installed correctly.

Severe impacts may compromise its stability other than its functionality.

Safety Measures:

- Do not hit the tool.
- Use the necessary safety equipment.

CAUTION



The device was manufactured to be electrically safe and to work with specific supply voltage levels.

Improper use may expose the operator to the risk of electric shock, even though of low intensity.

Safety Measures:

- Wear adequate personal protective equipment during all the operating phases.
- Do not handle or touch the device or any accessories (e.g. cables) with wet hands.

WARNING



The current used during the operating phases generates Electro-Magnetic Fields (EMF) near the tool.

Even though of low intensity, these fields may interfere with medical prostheses, such as pacemakers.

Safety Measures:

- Keep away from the device after launching the operating phases.
- If you have a medical prosthesis (e.g.: pacemaker), check with your doctor as to the appropriateness of using the device or being near it.

3.4 Device Safety

NOTICE



The device was designed to be used in specific environmental conditions.

Using the device in environments with temperatures and humidity that differ from those specified may impair its efficiency.

Safety measures:

- Always place the device in a dry area.
- Keep the device at a minimum distance of 1 metre from the walls.

- *Do not expose or use the device close to heat sources.*
- *Do not use corrosive chemicals, solvents or harsh detergents to clean the device.*

NOTICE



The device was designed to be mechanically tough and suitable for use in a workshop.

Careless use and excessive mechanical strain may impair its efficiency.

Safety measures:

- *Do not drop, shake or knock the device.*
- *Do not carry out any type of intervention that may damage the device.*
- *Do not open or disassemble the device.*

NOTICE



The device was manufactured to be electrically safe and to work with specific supply voltage levels.

Failure to comply with the specifications related to the power supply may impair the device's efficiency.

Safety measures:

- *Do not wet the device with water or other liquids.*
- *The device's power supply must always be connected following the indications provided in this manual.*
- *Do not use an external batteries to supply the device.*

! WARNING





The electromagnetic compatibility tests carried out on the device guarantee that it can be adapted to the technologies normally used on vehicles (e.g. engine control, ABS, airbag, etc.). Nevertheless, if malfunctions occur, contact the vehicle's dealer.

4 ENVIRONMENTAL INFORMATION



Do not dispose of this product with other undifferentiated solid waste.
For information regarding the disposal of this product please see the pamphlet supplied.

5 NORMATIVE INFORMATION

	<p>The manufacturer, TEXA S.p.A., declares that the radio equipment type IR CALIBRATION TARGET is in compliance with the following directives:</p> <ul style="list-style-type: none">• <i>RoHS 2011/65/UE and Delegated Directive 2015/863/EU</i>• <i>EMC 2014/30/UE</i>• <i>LVD 2014/35/UE</i> <p>The complete text of the EU declaration of conformity is available at the following Internet address http://www.texa.it/download.</p>
	<p>The manufacturer, TEXA S.p.A., declares that the radio equipment type IR CALIBRATION TARGET is in compliance with the following regulations:</p> <ul style="list-style-type: none">• <i>RoHS Regulation 2012 No. 3032</i>• <i>EMC Regulation 2016 No. 1091</i>• <i>Low Voltage Regulation 2016 No. 1101</i> <p>The complete text of the UK declaration of conformity is available at the following Internet address http://www.texa.it/download.</p>

6 IR CALIBRATION TARGET

IR CALIBRATION TARGET is a device that allows calibrating the infrared cameras used by the ADAS (Advanced Driver Assistance Systems).



Calibrating the cameras requires using:

- *a diagnostic tool connected to the vehicle;*
- *the calibration panel indicated by the diagnostic software;*
- *IR CALIBRATION TARGET.*

The calibration procedure is completely guided by the software.



For further information see the specific help sheets available in the diagnostic software.



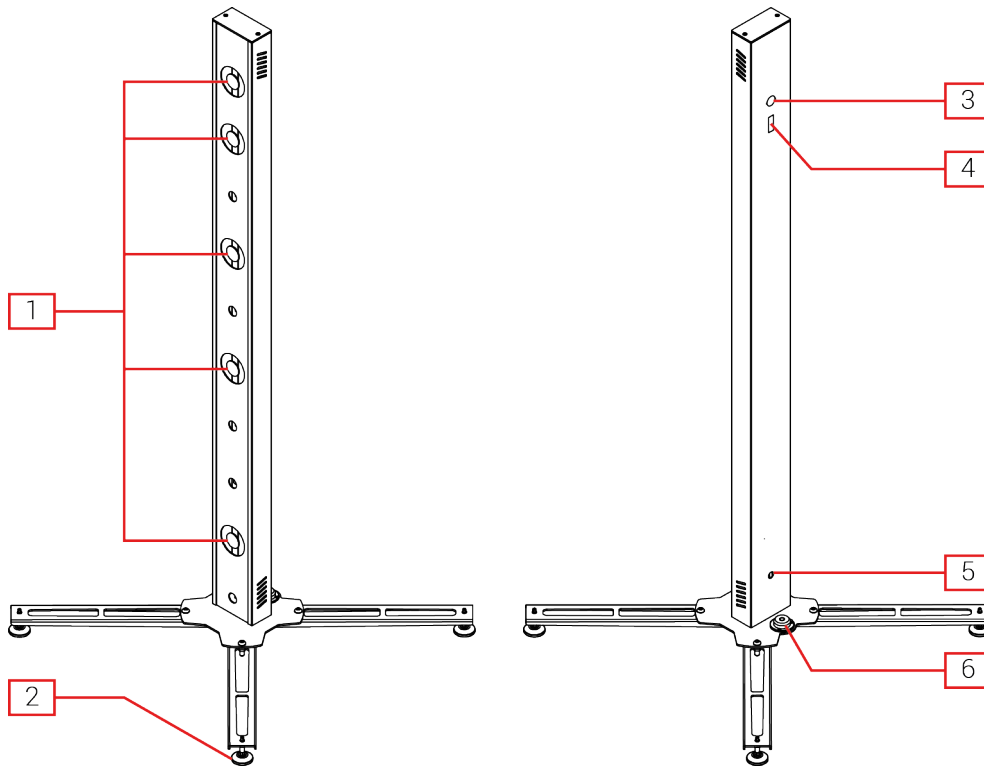



7 DESCRIPTION

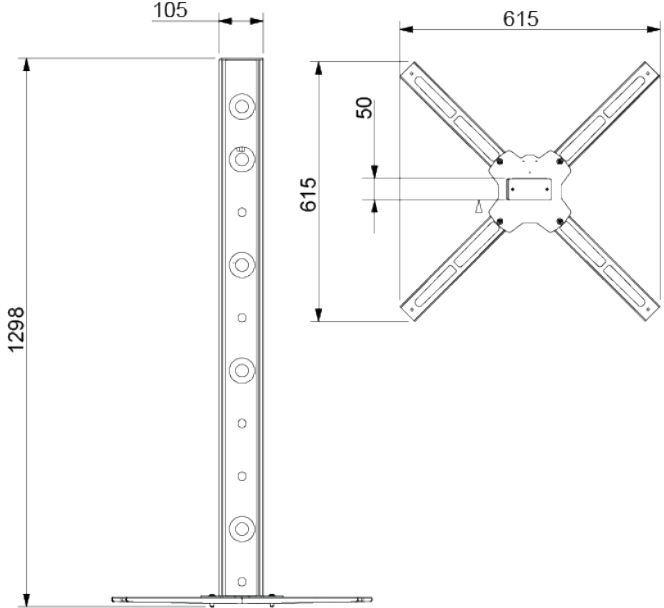

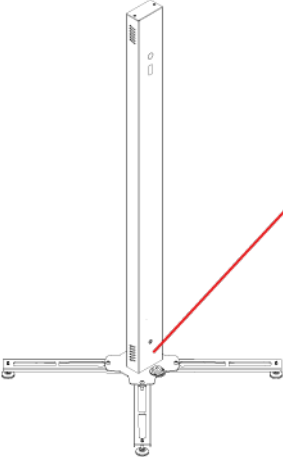
1. IR emitters
2. Adjustable feet (x4)
3. ON/OFF switch
4. Protection fuse
5. Connector for external power adapter
6. Levelling bubble

8 TECHNICAL FEATURES

Manufacturer:	TEXA S.p.A.
Product name:	IR CALIBRATION TARGET
Power supply:	12 V _{DC}
Charger:	<p>External power adapter mod.:GST60A12-P1J</p> <ul style="list-style-type: none"> • <i>Input:100-240 Vac 50/60 Hz 1,4 A</i> • <i>Output:12 V_{DC} 5 A</i> • <i>Socket:IEC60320-C14</i> • <i>Cable:H05 VV-F</i> • <i>Cable:SJT(for American market)</i>
Maximum consumption:	3 A
Emitters:	<p>5 IR emitters</p> <p>Operating temperature:$47 \pm 2 \text{ }^{\circ}\text{C}$</p>
Fuse:	Italwber mod. 0403153, 5x20 250 V 3.15 AF
Operating temperature:	$0 \text{ }^{\circ}\text{C} \div 45 \text{ }^{\circ}\text{C}$
Storage temperature:	$- 20 \text{ }^{\circ}\text{C} \div 60 \text{ }^{\circ}\text{C}$
Storage and operation moisture:	$10 \% \div 80 \% \text{ HR}$
Dimensions [mm]:	 <p>The drawing shows two views of the device. The front view is a vertical rectangular bar with a height of 1298 mm and a width of 105 mm. It features five circular emitters along its length. The top view shows a cross-section with a width of 615 mm and a height of 615 mm. The four corners are rounded, and there are four diagonal slots extending from the center towards the corners. A dimension of 50 mm is indicated for the distance from the center to the edge of the diagonal slots.</p>
Weight:	8 kg
Environmental conditions	<ul style="list-style-type: none"> • <i>Use:indoors</i> • <i>Altitude (up to):2000 m</i> • <i>Supply voltage fluctuations:$\pm 10\%$</i> • <i>Overvoltage category:II</i> • <i>Pollution degree:3</i> • <i>Maximum relative humidity 80% for temperatures up to $31 \text{ }^{\circ}\text{C}$, linearly decreasing to 50% at $40 \text{ }^{\circ}\text{C}$</i>

Directives:	RoHS 2011/65/UE and Delegated Directive 2015/863/EU LVD 2014/35/UE EMC 2014/30/UE
Regulations:	RoHS Regulation 2012 No. 3032 Low Voltage Regulation 2016 No. 1101 EMC Regulation 2016 No. 1091
Standards:	EN 61010-1 EN 61326-1
Data plate:	 <div data-bbox="1070 577 1442 931" style="border: 1px solid black; padding: 5px;"> <p>TEXA S.p.A. 31050 Via 1° Maggio 9 Monastier di Treviso (TV) - Italy IR CALIBRATION TARGET</p> <hr/> <p>POWER SUPPLY 12V = 3.0A  </p> <p>Temp (°C) 0 ÷ 45</p> <p>MADE IN ITALY    </p> </div>

9 PRELIMINARY OPERATIONS

The device is delivered disassembled: it must be assembled before use.

CAUTION



The assembly procedure was designed to be simple and safe and to make the device solid and stable.

An inadequate assembly may compromise the device's stability, with consequences on its proper operation and the operator's safety.

Carefully follow the instructions below.

Wear adequate personal protective equipment at all times while assembling the device.

Proceed as follows:

1. Unpack the device carefully.
2. Using the provided screws, fasten plate A to the base of the column.

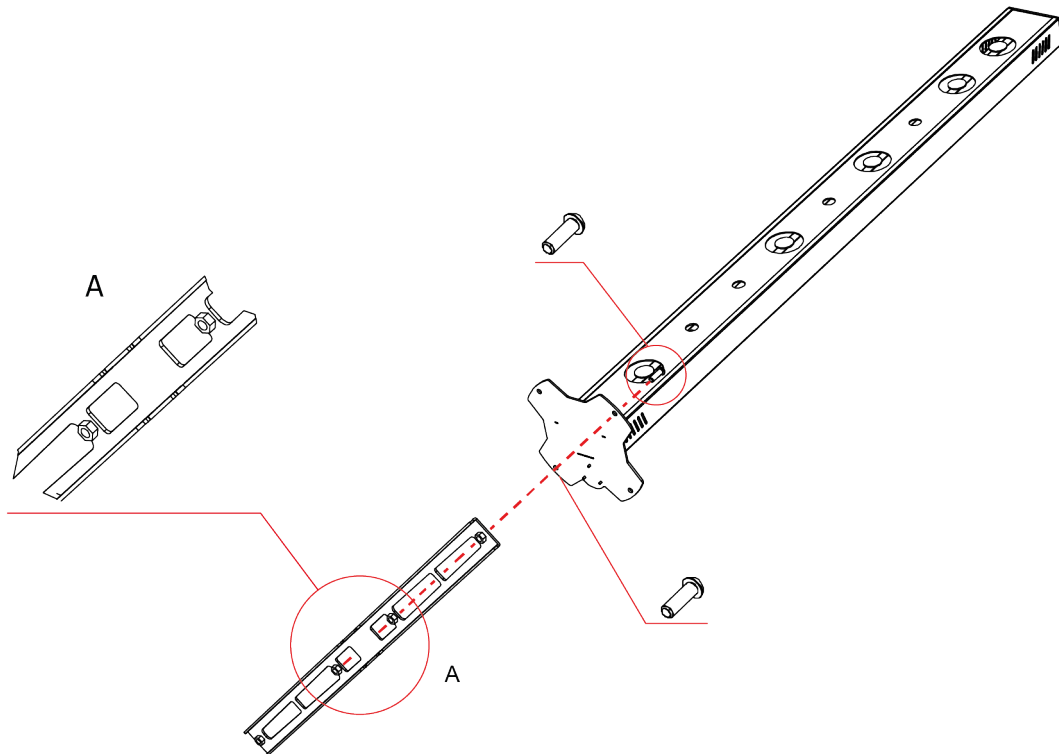

3. Fit plate B onto plate A.

4. Using the provided screws, fasten plate B to the base of the column.

5. Screw the adjustable feet to the two plates.

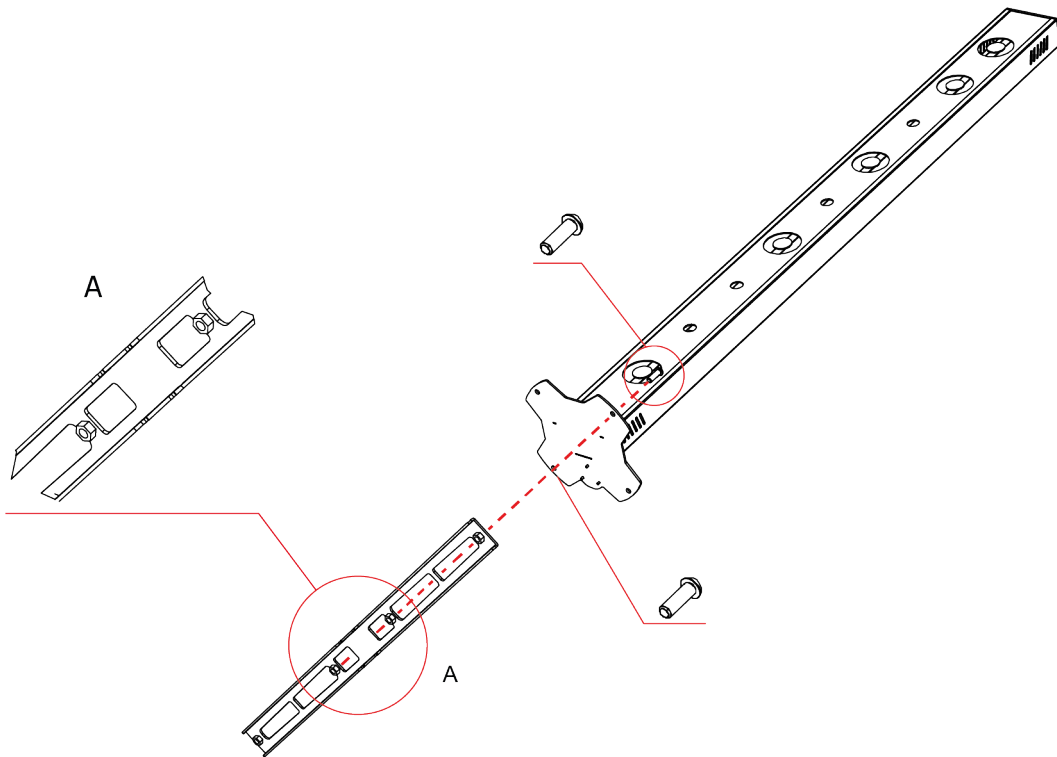

6. Lay the device on a flat surface.

7. Adjust the feet until the device is levelled.

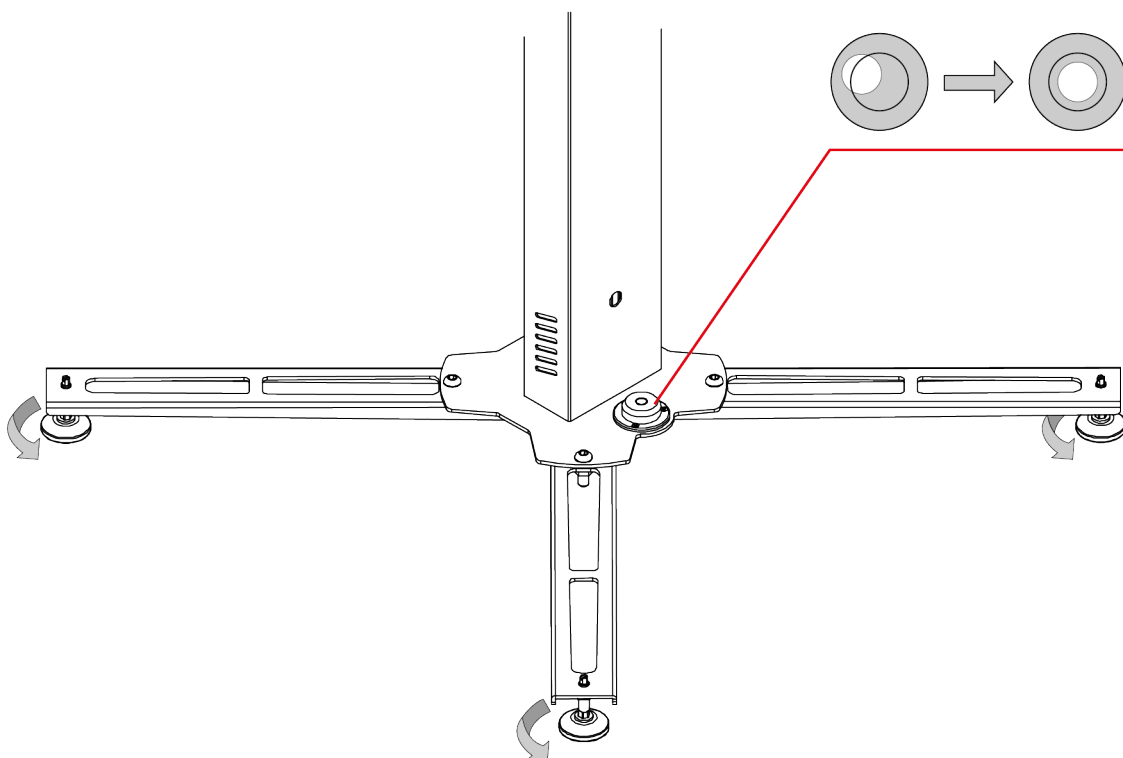

10 POWER SUPPLY

The device is powered by the mains through a specific external power adapter.

⚠ CAUTION

The use of different chargers other than the one indicated can damage the device and expose the operator to the risk of injuries.

If the tool is not used as specified by the manufacturer, the protection provided by the tool may be altered.

The mains plug must be used to disconnect from the mains.

Do not position the tool so that it becomes difficult to disconnect it from the mains.

Only use the power adapter:

- Model:GTS60A12-P1J
- Code:3907331

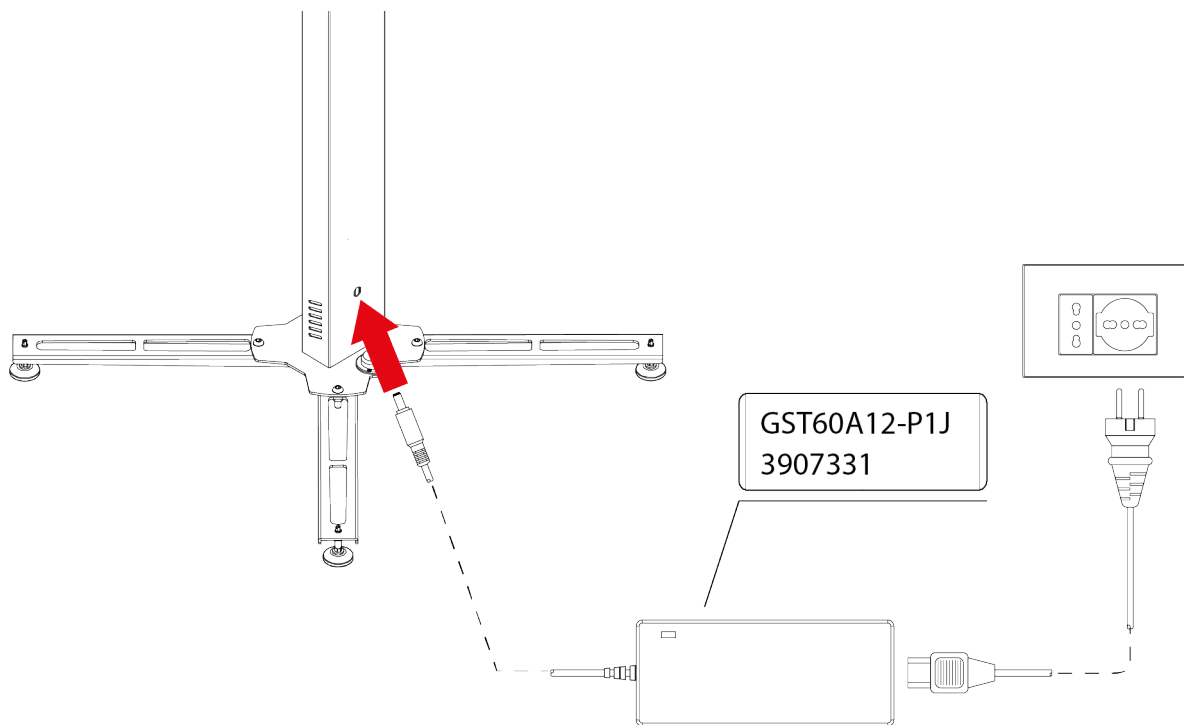

Proceed as follows:

1. Connect the external charger's jack to the connector located on the rear side of the device.
2. Connect the power supply cable to the external power adaptor.
3. Connect the power cable's plug to the mains.

11 POWER ON/OFF

The switch on the back of the device is its power switch.

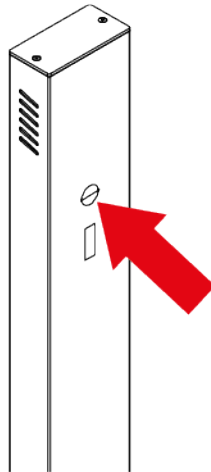

Proceed as follows:

1. Set the switch to position ON.

INFORMATION

At temperatures around 20 °C the device must remain on for at least 30 - 60 seconds before performing a test / calibration.

To turn off the device, proceed as follows:

1. Set the switch to position OFF.

NOTICE



Turning off in other ways rather than the ones indicated may damage the device.

Do not turn off the device by disconnecting it from the mains.

12 PERFORMING A TEST / CALIBRATION

In order to perform a test/calibration, you must have the following:

- *display unit equipped with specific diagnostic software;*
- *diagnostic tool properly configured.*

Proceed as follows:

1. *Make sure the device is levelled and eventually adjust the feet so it is perfectly even.*
2. *Make sure the device is at a minimum distance of 1 metre from the walls.*
3. *Set the ignition switch to ON.*
4. *Wait at least 30 - 60 seconds before starting the test.*
5. *Connect the diagnostic tool to the vehicle's diagnostic socket.*
6. *Start the specific software function for calibrating the sensors.*
7. *Arrange the camera calibration panels as indicated by the diagnostic software.*
8. *Position the device as indicated in the help sheet available in the diagnostic software.*
9. *Follow the on-screen instructions provided by the software.*



For further information see the diagnostic tool's Technical Manual and the software's Operating Manual.

13 MAINTENANCE

This product does not require special maintenance. However, we recommend the following:

- *carefully follow the instructions provided in this manual;*
- *keep the product clean using a slightly damp cloth (do not use solvents or corrosive products);*
- *periodically inspect the electrical connections making sure they are in good conditions;*
- *immediately replace any damaged cables;*
- *only use original spare parts or spare parts approved by the manufacturer;*
- *contact your retailer for extraordinary maintenance operations;*

NOTICE



The use of spare parts and accessories that are not approved by the manufacturer may compromise the product's efficiency and safety.

Only use spare parts and accessories that are approved by the manufacturer.

Contact your retailer for any maintenance operation that is not described below.

You can see the list of authorised retailers at the following address: <https://www.texa.com/sales-network>

13.1 Fuse Replacement

If blown, the cartridge fuse [F] must be replaced with one with the same technical features:

- *Italwber mod. 0403153, 5x20 250 V 3.15 AF*

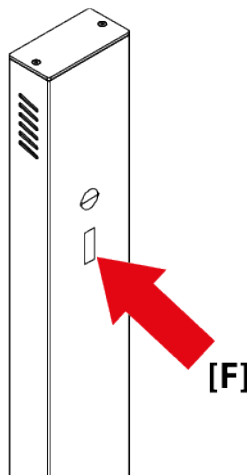

! WARNING



Disconnect the power adapter from the device and from the mains before carrying out any of the operations described.

Proceed as follows:

1. *Set the switch to position OFF (0).*
2. *Pull out the fuse housing.*

3. *Remove the blown fuse.*
4. *Replace the fuse with one that has the same technical features.*
5. *Reinsert the fuse housing.*

14 TROUBLESHOOTING

For any technical problem contact your distributor/retailer.

Below you will find a list of simple instructions that the customer can carry out without having to ask for technical assistance.

PROBLEM	PROBABLE CAUSE	POSSIBLE SOLUTION
The device is not switching on.	The protection fuse is blown.	Replace the fuse with an identical one.
The calibration is not successful.	The device is not levelled.	Adjust the feet to make the device become perfectly even.
	The procedure was started before the time needed for the emitters to heat up elapsed.	Wait for the emitters to heat up. Repeat the procedure.
	The distances and positioning indicated by the software were not met.	Position the device as indicated by the software. Repeat the procedure.

15 LEGAL NOTICES

TEXA S.p.A.

Via 1 Maggio, 9 - 31050 Monastier di Treviso - ITALY

Tax Code - Company Register of Treviso ID No. - VAT No.: 02413550266

Single-shareholder company subject to the direction and coordination activities of Opera Holding S.r.l.

Paid-up share capital 1,000,000 € - R.E.A. (Economic Administrative Index) No. 208102

Legal Representative Bruno Vianello

Phone +39 0422.791.311

Fax +39 0422.791.300

www.texa.com

For information regarding the legal notices, please refer to the **International Warranty Booklet** provided with the product.